

Contents

	<i>Page</i>
1. Introduction	4
1.1 Reason for this Guide	4
1.2 Interpretation	4
1.3 Principles of Fire Safety	4
1.4 Legal Provisions	5
2. Scope and Application	7
2.1 Scope of the Guide	7
2.2 Premises to which the Guide applies	7
2.3 Application of the Guide	7
2.4 Equivalent Fire Safety	7
3. Management of Fire Safety	8
3.1 General	8
3.2 Fire Safety Programme	8
3.3 Fire Prevention	8
3.4 Staff Training	10
3.5 Emergency Procedures and Evacuation Drills	11
3.6 Fire Safety Instructions	11
3.7 Inspection and Maintenance of Fire Protection Equipment	12
3.8 Maintenance of the Building, Fittings and Services	12
3.9 Maintenance of Escape Routes	12
3.10 Liaison with the Fire Authority and Assisting the Fire Brigade	13
3.11 Fire Safety Records	13
3.12 Maintenance of Fire Safety Signs and Notices	14
4. Means of Escape	15
4.1 Introduction	15
4.2 Principles of Escape Route Design	15
4.3 Horizontal Escape Routes	16
4.4 Vertical Escape Routes	21
4.5 Escape Routes : General Provisions	28
4.6 Fire Detection and Alarm Systems	29
4.7 Emergency Lighting	29
4.8 Signposting of Escape Routes	30

	<i>Page</i>
5. Structural Fire Precautions	31
5.1 Introduction	31
5.2 Compartmentation	31
5.3 Elements of Structure	31
5.4 Fire Resistance	31
5.5 Fire Resistance for Elements of Structure	32
5.6 Places of Special Fire Risk	32
5.7 Construction Details	33
5.8 Wall and Ceiling Finishes	33
5.9 Fire Doors	34
6. Building Services	37
6.1 General	37
6.2 Electrical Services	37
6.3 Gas Services	37
6.4 Heating Systems	38
6.5 Ventilation Systems	38
7. Furnishings and Fittings	39
7.1 General	39
7.2 Seating	39
7.3 Vertical Hangings	39
7.4 Floor Coverings	39
7.5 Bedding	40
7.6 Miscellaneous	40
7.7 Test Certificates	40
8. Fire-Fighting Equipment	41
8.1 General	41
8.2 Portable Fire Extinguishers	41
8.3 Hose Reels	42
8.4 Fire Blankets	42
8.5 Places of Special Fire Risk	42
9. Access and Facilities for the Fire Service	43
9.1 General	43
9.2 Access	43
9.3 Facilities for the Fire Service	43

	<i>Page</i>
Glossary	44
Appendix A	Fire Services Act, 1981 46
Appendix B	Building Control Act, 1990 48
Appendix C	Registration and Renewal of Registration Regulations, 1996 for (I) Holiday Hostels and (II) Youth Hostels under the Tourist Traffic Acts, 1939 - 1995 51
Appendix D	In Case of Fire 52
Appendix E	Procedure for Calling the Fire Brigade 53
Appendix F	Fire Safety Register 54
Appendix G	Sample Fire Safety Instructions to Guests 55
Appendix H	Materials of Construction 56
Appendix I	Reference Standards 58
Appendix J	Reference Publications 61

Chapter 1 Introduction

1.1 Reason for this Guide

The purpose of this Guide is to assist persons in discharging their statutory fire safety responsibilities under the Fire Services Act, 1981 in relation to hostels.

Section 18(2) of the Act places a duty on persons having control over premises to which this section applies to

"take all reasonable measures to guard against the outbreak of fire on such premises"

and

"ensure as far as is reasonably practicable the safety of persons on the premises in the event of an outbreak of fire".

Section 18(3) places a duty on every person on such premises to conduct himself in such a way as to

"ensure that as far as is reasonably practicable any person on the premises is not exposed to danger from fire as a consequence of any act or omission of his".

Premises to which Section 18 applies include those used :

- as or for any purpose involving the provision of sleeping accommodation;
- for purposes of entertainment, recreation, or instruction; and
- for any purpose involving access by the public whether on payment or otherwise.

While the Guide is aimed primarily at persons in control such as owners, occupiers and managers, it also has application to staff, guests, visitors and maintenance personnel. The Guide may also assist persons responsible in discharging many of their fire safety duties under the Bord Fáilte Hostels Regulations, 1996.

1.2 Interpretation

Users of the Guide are advised that the interpretation and application of the technical recommendations of the Guide should be entrusted to suitably qualified and competent persons. The recommendations contained in Chapters 4 to 9 in particular are of a technical nature. They are primarily intended to be used by advisers to the persons having control over hostels and by officers of fire authorities.

It is recognised that as existing hostels are located in many different building types there will be a need for flexibility in the implementation of the Guide's recommendations in particular cases. The provisions of the document are an aid to, and not a substitute for, professional judgement and common sense.

This Guide refers to a number of technical standards, codes of practice and reference publications, Appendices I and J refer. It is important for users of the Guide to refer to the latest edition of a standard, code or reference publication together with the latest published amendments.

The diagrams in this Guide are not drawn to scale. They are intended to illustrate points under discussion and should not be interpreted in any other way.

1.3 Principles of Fire Safety

The fire safety principles on which the Guide is based are adopted primarily to protect life. These principles may be summarised as follows :

- management of fire safety;
- avoidance of outbreaks of fire;
- early detection of fire and early warning to staff and guests to facilitate an adequate response;
- compartmentation of building and provision of escape routes, which are protected from fire and smoke;

- limitation of the development and spread of fire;
- containment of fire and smoke to the room where the fire originates;
- early suppression of fire, where this is feasible;
- effective evacuation procedures; and
- access and facilities for the fire service.

1.4 Legal Provisions

1.4.1 The primary legislation relating to fire safety in buildings in Ireland is the Fire Services Act, 1981 and the Building Control Act, 1990 and regulations made under these Acts. The Bord Fáilte Hostels Regulations, 1996 are also relevant.

The recommendations in this Guide are advisory only and are not statutory requirements. Compliance with them does not confer immunity from statutory obligations nor exempt a person from the need to ensure that any relevant statutory requirements are complied with.

1.4.2 Fire Services Act, 1981

The Fire Services Act, 1981 makes provision for the establishment of fire authorities and the organisation of fire services and for fire safety, fire-fighting, the protection and rescue of persons and property, and related matters. The main provisions of the Fire Services Act, 1981 as it relates to hostels, are set out in Appendix A to this Guide.

1.4.3 Building Control Act, 1990

The Building Control Act, 1990, provides for matters relating to the construction, alteration, extension or change of use of buildings. The Building Regulations, 1997, set out the requirements, including fire safety requirements, to be observed in the design and construction of

certain buildings or works.

The Building Control Regulations, 1997 prescribe certain requirements to be observed in relation to the design and construction of buildings or works, including application for fire safety certificates and notice of commencement of works.

In an existing building, where works are required to achieve the standards of fire safety in accordance with the recommendations of this Guide, such works are not exempt from the requirements of building control legislation. However, in the case of a material alteration of an existing hostel, the requirements of certain parts of the Building Regulations in relation to such works may be met by the application of the provisions of this Guide.

The main provisions of the Building Control Act, 1990 and related regulations, as they relate to hostels, are set out in Appendix B to this Guide.

1.4.4 Bord Fáilte Hostel Regulations, 1996

If a premises is registered with Bord Fáilte, the Bord Fáilte Hostel Regulations, 1996 apply. The Regulations contain provisions for the purposes of ensuring that adequate and suitable facilities and accommodation are provided in hostels which are registered with Bord Fáilte. A registered hostel under this legislation must provide accommodation for 20 or more guests. For the purpose of registration, Bord Fáilte requires written evidence that the fire precautions in the premises are adequate. The main provisions of the Bord Fáilte Hostel Regulations, 1996 are set out in Appendix C to this Guide.

1.4.5 Safety, Health and Welfare at Work Act, 1989

The Safety, Health and Welfare at Work Act, 1989 places duties on employers and employees concerning the safety, health and welfare of persons

working in hostels. A number of regulations have been made under this Act and of particular importance for hostels is the Safety, Health and Welfare at Work (General Applications) Regulations, 1993 (S.I. No 44 of 1993) which deals with general safety and health provisions, workplace safety and health, use of work equipment, electricity, manual handling etc.

1.4.6 Copies of the above mentioned Acts and Regulations may be purchased from the Government Publications Sale Office, Sun Alliance House, Molesworth Street, Dublin 2.

Chapter 2 *Scope and Application*

2.1 Scope of the Guide

This Guide addresses fire safety in existing hostels. It discusses and makes recommendations on building layout, construction, fire protection facilities, fire safety management and other measures to minimise the danger to life from fire.

The recommendations on fire safety management (see Chapter 3) apply to all hostels. The other recommendations of the Guide are intended to apply to hostels which were constructed and in use as hostels prior to the coming into operation of the Building Regulations in 1992.

2.2 Premises to which the Guide applies

Subject to Section 2.1 this Guide applies to all existing hostels, whether used on a full-time or seasonal basis and which provide sleeping accommodation in bedrooms and/or dormitories with common cooking/dining, laundry and other facilities.

2.3 Application of the Guide

The Guide sets out general principles of safety which should be applied having regard to the individual circumstances of each premises. Factors such as the number of storeys, the form of construction, internal layout and the number of persons to be accommodated, affect life safety and, consequently the level of fire protection required in a particular case.

In each case it is necessary to consider :

- the effects of a fire occurring in any room or part of the building;
- the danger that this poses to life safety;
- the fire protection provided in the premises; and
- the capacity of staff to respond effectively to an outbreak of fire.

Maximum benefit will be obtained only when the recommendations of the Guide as a whole are applied as part of a comprehensive approach to life safety. Correct application of the recommendations will help to minimise the occurrence of fires in hostels and the potential for fatalities, injuries and damage.

Persons having control over hostels are urged to review the fire safety of their premises by reference to the recommendations in this Guide. In many cases, the persons concerned will have been fully aware of the need for such precautions and will have taken action to ensure fire safety by measures of the type recommended in the Guide, or their equivalent.

Some of the recommendations of the Guide (e.g. fire safety management measures) are unlikely to involve significant additional expenditure. However, where major investment may be necessary to implement the Guide's recommendations, immediate steps should be taken to draw up a programme for the elimination of deficiencies on a planned basis with a view to achieving a structured remedying of deficiencies as soon as possible.

2.4 Equivalent Fire Safety

Guidance contained in this document with respect to the use of a particular material, method of construction, standard or other specification does not preclude the use of any other suitable material, method of construction, standard or specification which would achieve an equivalent level of fire protection.

The methods used to demonstrate equivalency should be based on fire safety engineering principles and the application of professional judgement. Guidance on the use of a fire safety engineering approach is contained in Technical Guidance Document B (Fire Safety) to the Building Regulations, 1997.

Chapter 3 *Management of Fire Safety*

3.1 General

As indicated in Chapter 1, persons in control of hostels have a statutory responsibility to take all reasonable measures to prevent the occurrence of fires and to ensure as far as reasonably practicable the safety of guests, staff or other occupants in the event of fire occurring on the premises. The occupants on the premises also have responsibilities in relation to fire safety.

This Chapter provides standardised procedures for the development and implementation of a fire safety programme which should be an integral part of the day-to-day management and operation of a hostel.

3.2 Fire Safety Programme

A fire safety programme incorporating arrangements for the following should be prepared for each individual premises :

- prevention of outbreaks of fire, through the establishment of day-to-day fire prevention practices;
- instruction and training of staff on all matters relating to fire safety;
- emergency fire procedures and evacuation drills;
- provision of fire safety instructions to the guests;
- inspection and maintenance of fire protection equipment;
- maintenance of the building and its fittings and services;
- maintenance of escape routes;
- liaison with the fire authority and assisting the fire brigade; and
- keeping of fire safety records.

A fire safety programme will only be effective if it is implemented in total, and monitored on a day-to-day basis by the persons in control of the hostel.

Most of the areas covered in this Chapter are matters of good housekeeping. They can generally be implemented without significant cost implication and will result in an immediate improvement in fire safety standards in a premises.

3.3 Fire Prevention

3.3.1 Fire prevention measures are a key element in the fire safety management of hostels. This involves the identification and elimination of potential fire hazards both inside and outside the building, and the establishment of good housekeeping practices, periodic inspections and the diligent application of safety rules. The following fire prevention measures are recommended for adoption in the day-to-day running of premises. A notice outlining the main points of concern should be displayed for the information of the occupants in all appropriate areas (see Appendix G).

3.3.2 Rubbish and Waste

Combustible waste materials such as waste-paper, wrappings etc. are frequently the fuel involved in starting fires, and proper arrangements should be made for collection and removal of waste at regular intervals. Pending removal, rubbish and waste should be stored in suitable containers at a designated location, away from sources of ignition. Staff and guests should be made aware of the importance of keeping all areas of the premises clean and tidy. Rubbish and waste should not be allowed to accumulate in stairways or escape routes.

3.3.3 Smoking

Smoking and careless disposal of smokers' materials is one of the most common causes of accidental fires. Where permitted, smoking should be restricted to approved areas. "No Smoking" signs should be displayed in areas where it is forbidden. Smoking should be prohibited in dormitories, bedrooms, stores, laundries and in kitchen areas. In areas where smoking is permitted, suitable ashtrays should be provided. Ashtrays should be emptied frequently into metal bins, with any smouldering material being extinguished beforehand.

3.3.4 Storage of Gas Cylinders/Cartridges

Any LPG gas containers should be stored outside the building in a separate designated well ventilated and secure store (see Chapter 6).

3.3.5 Electrical Installations and Appliances

Inspection and testing of the electrical installation and appliances in hostels is dealt with in Chapter 6 of this Guide. Staff should be trained to use electrical equipment correctly and safely, and to report defective electrical equipment. Defective equipment should not be used; repairs as appropriate should only be carried out by competent persons. Equipment should be switched off when not in use. Occupants should be advised as to the correct use of electrical appliances which may be provided in their bedrooms; care should be taken with the use of such appliances such as electric blankets, heaters, hair dryers etc.

3.3.6 Kitchens

Good housekeeping practices are essential for fire safety in kitchens. Cookers, extract fans, extraction hoods, filter ducts and ancillary equipment should be regularly cleaned of oil, grease and dust. Equipment should be serviced regularly. Gas, oil and electrical cut off switches and valves should be provided in clearly marked and accessible areas situated away from the equipment which they serve. Cooking should not be allowed late at night.

The occupants should be instructed on how to prevent fires occurring by :

- not leaving cooking operations unattended;
- taking care not to overheat fats/oils;
- not over-filling cooking pans; and
- not leaving combustible materials (e.g. towels, etc.) over stoves.

Occupants should also be familiar with the location and correct use of available first aid fire-fighting equipment in kitchens e.g. fire extinguishers, fire blankets and any fixed fire suppression systems.

3.3.7 Laundries

A separate room should be dedicated for use as a laundry or utility room. Such rooms pose particular fire hazards as detailed below.

- (a) Spontaneous combustion of compacted fabrics which have been tumble dried. Tumble dryers should have automatic cooling at the end of the drying cycle. Fabrics should not be over-dried and tumble dryers should be unloaded immediately after use and left empty. Tumble-dried fabrics should be separated and folded as soon as practical, but in any case should be loosened to dissipate heat on being taken from the machine. Ironing equipment should be switched off when not in use.
- (b) Solvents which are highly flammable are sometimes used for spot cleaning in laundries. Only small quantities needed for immediate use should be kept in the laundry. The main bulk of this type of liquid and general cleaning solvents should be stored outside the building in a well ventilated secure store. Containers for solvents should

be kept closed to prevent the vapours leaking. Smoking should be prohibited in laundries and signs to this effect should be displayed.

- (c) Fluff or lint which is extremely flammable can accumulate in laundries. A programme should be instituted to remove build-up of such materials, especially from hot areas such as electric motors, and other hidden locations.

3.3.8 Open Fires and Portable/Fixed Radiant and Convector Type Heaters

Open fires or portable heaters should not be provided in bedrooms or dormitories. Where an open fire or portable radiant type heater is provided in a common area i.e. a sitting room or lounge, it should be protected by a strong spark-proof fireguard. Fuel and lighting materials should be stored safely. Heaters should not be used for drying clothing and appropriate notices to this effect should be displayed beside such heaters. Clothing etc. should not be placed on or near convector or storage type heaters.

3.3.9 Fire Doors

Fire doors are an important part of the fire defence system in hostels and should normally be kept closed. The occupants should be made aware of the vital role which such doors play, and of the importance of not propping or wedging them open. This message should be emphasised by appropriate "Fire Door-Keep Shut" signs displayed on each fire door. In situations where it is necessary for operational reasons to hold open such doors, this should be done with electro-magnetic devices linked to an automatic alarm system (see also Section 5.9.3); such doors should be closed at night.

3.3.10 Storage of Luggage

Adequate facilities should be provided for the

storage of luggage. Luggage should not obstruct any escape route or fire safety sign.

3.3.11 Maintenance and Repair

Adequate fire precautions should be taken when any hot work is undertaken e.g. soldering, welding, etc. and work persons should be carefully supervised.

3.4 Staff Training

Staff to guest ratio in hostels is generally low and the fire safety duties may be carried out directly by the person in charge.

For a fire safety programme to be effective, staff should be familiar with the parts of the fire safety programme in which they have a role to play. Comprehensive instruction and training on the relevant areas should be given to all staff including part-time and temporary staff. A record of the training undertaken by the staff should be kept in the Fire Safety Register (see Section 3.11).

Staff should receive training and instruction in relation to the following :

- the fire prevention measures indicated in Section 3.3 above;
- the action to be taken on hearing the fire alarm;
- the action to be taken on discovering a fire;
- the evacuation procedure devised for the premises;
- the layout of the building including escape routes;
- the location of fire alarm call points and fire-fighting equipment;
- the location of the main fire alarm control and indicating panel and any associated alarm panels and their operation;

- the procedure for calling the fire brigade and ambulance;
- the role of fire doors in controlling fire and smoke spread;
- arrangements for assisting the fire brigade;
- fire control techniques including the use of first aid fire-fighting equipment; and
- the operation of building services to minimise fire and smoke spread.

3.5 Emergency Procedures and Evacuation Drills

If a fire or an emergency situation occurs in a premises it is imperative to respond effectively by calling the fire brigade, evacuating the premises and controlling the incident, if safe to do so, until the arrival of the fire brigade. Accordingly a predetermined plan should be put in place outlining the procedures to be adopted as follows :

- a procedure for raising the alarm;
- a procedure for investigating automatic alarms;
- a procedure for calling the fire brigade;
- an evacuation procedure for the occupants, including persons with special needs;
- a procedure for fighting the fire using first aid fire-fighting equipment;
- a procedure for reporting to a pre-determined assembly point and informing a designated person(s) of the situation;
- a procedure for accounting for each person on the premises; and

- a procedure for assisting the fire brigade on their arrival.

To assess the effectiveness of the predetermined plan and preparatory training given, drills which simulate fire and emergency situations should be carried out on a regular basis. These drills can generally be organised for times which cause minimum disruption to the operation of the premises, but all staff must be involved. The objective of drills are generally :

- to familiarise persons in control with their roles;
- to test the availability and effectiveness of staff training;
- to test arrangements for an emergency situation; and
- to identify shortcomings in the emergency procedures.

Each drill should be reviewed afterwards and procedures revised if necessary. Drills should be recorded in the Fire Safety Register.

3.6 Fire Safety Instructions

Written instructions on the action to be taken by the occupants on the discovery of a fire or on hearing the fire alarm should be displayed in a prominent position in each dormitory, bedroom, kitchen and common room. These instructions should be multi-lingual as appropriate. Instructions should be accompanied by a simple floor plan showing schematically the location of alternative storey exits. Particular attention should be drawn to the fact that lifts should not be used in the event of fire (except for lifts which are specially protected from fire).

The type of notice required together with the fire safety instructions to guests is given in Appendix D. A notice

should also be displayed beside phones in the premises outlining the procedure for calling the fire brigade (see Appendix E).

3.7 Inspection and Maintenance of Fire Protection Equipment

The safety and protection of the occupants in the event of a fire will depend greatly on the reliable functioning of fire protection equipment such as fire detection and alarm systems, sprinkler systems, emergency lighting systems and fire extinguishing equipment. In existing buildings, a high degree of reliance may be placed on such "active" fire precautions, and accordingly, management must ensure that such equipment is operated and maintained to the appropriate standards.

All such equipment should be inspected on a regular basis. Details of inspection procedures for fire protection equipment are given in Chapter 8 of this Guide dealing with that equipment. If faults/deficiencies are discovered they should be noted and corrective action should be taken as well as any appropriate steps to prevent a recurrence.

In addition to regular in-house inspections specified in the Fire Safety Register, it is also necessary that equipment is maintained and serviced at recommended intervals and that a record is kept of this work. Maintenance contracts should be arranged with competent companies or persons in accordance with the appropriate standards.

3.8 Maintenance of the Building, Fittings and Service

Hazardous situations may develop if the condition of the building itself deteriorates over time. The integrity of walls, doors or floors which are part of fire compartmentation or the protection of escape routes must always be maintained.

The fittings, equipment and services in the building may cause or contribute to fire. Arrangements should be made for the regular checking of furnishings and fittings, electrical installation and appliances, gas-burning appliances, heating,

kitchen and laundry equipment. A record of these checks, as well as deficiencies and remedial and maintenance work, should be kept in the Fire Safety Register.

3.9 Maintenance of Escape Routes

In the event of a fire or other emergency, occupants should be able to evacuate the premises quickly and safely by way of routes protected from fire and smoke and free from obstruction. This can only be achieved if escape routes are unobstructed, if fire resisting doors are kept closed, and if exit doors are readily used at all times while the premises is occupied. All escape routes should be inspected on a regular basis. If any obstruction is noticed in the areas of escape, then it should be removed immediately and any necessary steps taken to prevent a recurrence. It is recommended that prominent signs should be erected at points where problems can occur in this regard.

Regular inspection of escape routes should be carried out to ensure that :

- escape routes are not obstructed and are immediately available for use;
- escape routes are clearly indicated, sign-posted and adequately illuminated by the main and emergency lighting systems;
- exit doors are capable of being readily opened at all times;
- doors and gates across escape routes are secured in a manner that they can be easily and immediately opened by persons on the premises;
- curtains, drapes or hangings are not placed across or along an escape route in a manner which would impede or obstruct escape;
- mirrors are not placed across or along an escape route or adjacent to an exit in such a way as to confuse the direction of escape;

- floor coverings, rugs and mats are fixed or laid so that they do not present a trip or slip hazard during an evacuation, and are not used to prop open doors;
- fire resisting doors along escape routes are kept closed at all times, unless where they are held open with electro-magnetic devices linked to the fire alarm system during the day and closed at night;
- external areas at or near exits are kept free of vehicles, portable cabins, excavations and or other obstructions, so as to allow unimpeded escape to a place of safety; and
- doors, gates or traffic do not block escape routes from a concourse or yard to a place of safety in the open air.

3.10 Liaison with the Fire Authority and Assisting the Fire Brigade

3.10.1 Liaison with the Fire Authority

It may be appropriate to liaise and consult from time to time with the fire authority with the following objectives :

- familiarisation of the fire brigade with the premises;
- to ensure the availability of access and appropriate facilities for the fire brigade;
- assistance on fire safety management; and
- advice on fire safety matters generally.

3.10.2 Assisting the Fire Brigade

Access roads and facilities for fire brigade use should always be accessible. Facilities such as hydrants and other fire-fighting water supplies, dry-risers, foam inlets, etc. should be immediately available for use by the fire brigade.

3.10.3 Plan of Premises

A plan of the premises (preferably A4 page format) should be displayed at or near the entrance indicating the location of :

- staircases and escape routes;
- fire protection facilities including water sources;
- first aid fire-fighting equipment;
- gas and electricity supply shut-off points;
- storage of gas cylinders and other hazardous materials; and
- the control panel for the automatic detection and alarm system and the control device for any ventilation systems.

3.11 Fire Safety Records

A Fire Safety Register (Appendix F) should be kept as a complete record of all fire safety matters on the premises. This register should be kept on the premises at all times, be kept up-to-date, and should be available for inspection by an authorised officer of the fire authority.

The following information should be recorded in the Fire Safety Register :

- the name of the person in control i.e. the owner/occupier/manager, and any deputies;
- a plan of each floor of the premises on A4 sheets;
- details of instruction and training given to staff on fire safety and by whom;
- details of each fire and evacuation drill, the date thereof, the names of those taking part, and the type, objective and results of exercises held;

- details of fire protection equipment and systems in the premises, (water supplies, hydrants, alarm system, extinguishing system, etc.) type, number, location, etc.;
- details of inspections and tests carried out on fire protection equipment and systems, with brief comments on the results of the checks and actions taken (and by whom) to remedy defects;
- details of each inspection of the building itself, its fittings and services and the actions taken to remedy any defects found; and
- details of all fire incidents and false alarms that occur and the actions taken as a result.

3.12 Maintenance of Fire Safety Signs and Notices

All fire safety signs, notices and instructions which are provided for the guests, staff and the fire brigade should be prominently displayed and be fully and clearly visible at all times. Damaged items should be repaired or replaced. Special attention should be given to signs which form part of the emergency lighting in the building.

Chapter 4 Means of Escape

4.1 Introduction

When a fire occurs in a building, large quantities of smoke and gases are produced. Smoke and hot gases may travel considerable distances within a building and will present a direct threat to life. Visibility also is considerably reduced, thereby affecting the viability of escape routes within and from the building.

It is essential that escape routes are available to enable the occupants to reach a place of safety and that they are adequate and capable of being safely and effectively used at all times. Special consideration should be given to accommodating and providing for the safe evacuation of people with disabilities. This may include providing accommodation in appropriate parts of the building, arrangements for giving warning to persons with hearing disabilities and provision of assistance in an emergency to persons with special needs. Additionally, security arrangements should not be such as to impede the escape of persons from the building in the event of an outbreak of fire.

In examining the means of escape, it is necessary to consider the evacuation process. Evacuation can be subdivided into distinct phases, as follows :

- Phase 1 : evacuation from the room or area to a common corridor, a protected stairway or to a final exit;
- Phase 2 : evacuation via a common corridor to a protected stairway or a final exit; and
- Phase 3 : vertical evacuation via a protected stairway to a final exit and a designated assembly point.

Phases 1 and 2 involve horizontal movement away from the immediate danger of the fire while Phase 3 involves vertical movement from the upper storeys. Vertical movement will generally be by way of protected stairways to a place of safety outside the building. In limited circumstances (see

Section 4.4.7), evacuation from the building may be by way of an external escape stairway. In the case of a single storey building, evacuation will be by way of final exits directly to a place of safety in the open air.

4.2 Principles of Escape Route Design

4.2.1 Components of Escape Routes

The means of escape provisions consist of the following components :

- horizontal escape routes (see Section 4.3);
and
- vertical escape routes (see Section 4.4).

In single storey buildings, the means of escape will consist of horizontal escape routes only, while multi-storey buildings will require a combination of these two components.

4.2.2 Number of Escape Routes

As a general principle, alternative escape routes should be available so that a person confronted by fire can escape in a direction which is away from the fire.

Each storey of the building should be provided with at least two escape routes, except in the case of a small premises which under certain conditions may be served by a single escape stairway (see Section 4.4.4). This provision is based on the possibility that, in the event of an outbreak of fire, one of the escape routes may become unavailable for use. Alternative escape routes from a storey should be remote from, and independent of each other.

In addition to a minimum of two escape routes from every storey, the floor layout and occupant capacity will also influence the number of escape routes required for any situation. It is necessary to restrict the distance to be travelled along an escape route.

The limitations on travel distance will depend on whether escape is possible in one direction or in more than one direction. The number of escape routes will also be influenced by the capacity of those routes to evacuate each area, taking into account the possibility of an escape route being unavailable for use as a result of the fire.

A single escape route from a storey is only acceptable where there is little likelihood of this route being unavailable for use and an alternative escape route cannot practicably be provided (see Section 4.4.4).

4.2.3 Width of Escape Routes

Escape routes should be sufficiently wide to enable evacuation of the occupant capacity of the rooms or areas they serve. Minimum widths for escape routes are indicated in Sections 4.3 and 4.4 below.

4.2.4 General Provisions for Means of Escape

Section 4.5 indicates general provisions (such as the protection of escape routes, doors on escape routes, etc.) in relation to the means of escape.

Section 4.6 indicates the fire detection and alarm systems which are required to give early warning in the event of an outbreak of fire to facilitate effective evacuation of the premises and an appropriate staff response.

Section 4.7 indicates the emergency lighting provisions which are required to ensure that there is sufficient lighting in the event of full or partial failure of the power supply to the normal lighting systems.

4.3 Horizontal Escape Routes

4.3.1 Components of Horizontal Escape

The horizontal escape routes may be sub-divided into the following components :

- travel within rooms; and
- horizontal travel from rooms to a protected stairway or to a final exit.

4.3.2 Travel Distance

For the purposes of means of escape, the travel distances along an escape route from any point in a building should be restricted to an extent which is dependent on the availability of alternative escape routes. For this purpose, a distinction is made between :

- travel from any point from which escape can be made in one direction only (sometimes referred to as dead-end travel); and
- travel from any point from which escape can be made in more than one direction, by way of alternative escape routes.

The limitations on travel distance depend on whether travel is available in one direction only or in more than one direction. The former is more restrictive, due to the increased risk of a single escape route becoming unusable in a fire.

Travel distances from all parts of a hostel should generally be within the maximum travel distances indicated in metres in Table 4.1 below.

Table 4.1

Limitations on Travel Distance		
Location	Available Escape Routes	
	One Direction Only	More Than One Direction
Bedroom/Dormitory	10 m	20 m
Bedroom corridors	10 m	35 m
Elsewhere	20 m	35 m

The maximum travel distances indicated in Table 4.1 should be regarded as guidelines, rather than strict limits. However, any departure from the tabulated values should be on the basis of professional judgement, taking into account the existence of any compensating fire safety measures.

Travel distance from any point is measured along the escape route to the nearest :

- (a) final exit;
- (b) door to a protected escape stairway;
- (c) door to an external escape route, where permitted (see Section 4.4.7);
or
- (d) (within a bedroom or dormitory)
door to a protected corridor.

Diagram 1 illustrates the limitations on travel distance for escape in one direction only and in more than one direction for a typical corridor arrangement.

Diagram 1
Travel distance

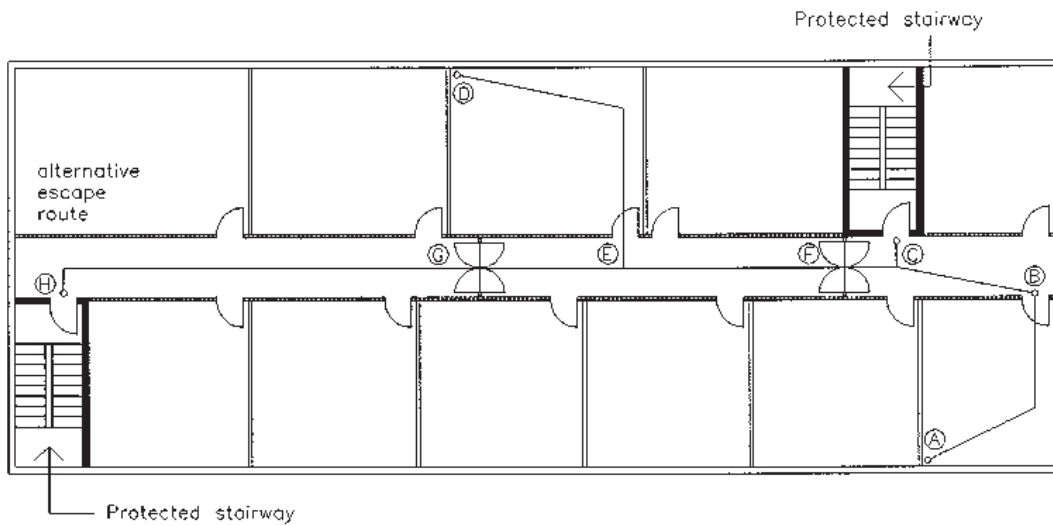

TYPICAL FLOOR PLAN

Travel distance





A to B to C : 10m maximum

D to E : 10m maximum

E to F to C : 35m maximum

Corridor sub-division at G approximately
midway between C and H (see 4.3.4)

F to G : 35m maximum

KEY		Fire resisting construction (see table 5.1)
		30 minutes fire resisting construction
		fire door FD 30 S
		fire door FD 30 S

Notes

- (1) See Section 4.3.2 and Table 4.1 on travel distance limitations.
- (2) See Section 4.3.4 for escape corridor provisions.
- (3) See Section 4.4.3 for number and location of escape stairways.
- (4) See Chapter 5 in relation to fire doors and structural fire precautions.

4.3.3 Escape from a Room

Alternative escape routes are required from a room in the following situations:

- (a) from any dormitory which may be occupied by more than 10 persons;
- (b) from any bedroom or dormitory where the travel distance exceeds 10 m;
- (c) from any other habitable room which is occupied by more than 50 persons; or
- (d) from any other habitable room where the travel distance exceeds 20 m.

For the purpose of the number of persons that may occupy a bedroom or dormitory the occupant capacity should be assessed by reference to the number of bed spaces provided. The maximum number of bed spaces provided in a dormitory should be on the basis of one person per every 2.79 m² of floor area.

The occupant capacity of rooms other than bedrooms or dormitories should be assessed in accordance with Table 1.1 of Technical Guidance Document B (Fire Safety) to the Building Regulations, 1997.

Habitable rooms should not be inner rooms, i.e. it should not be necessary to pass through another room to reach an escape corridor.



Where alternative escape routes from a room lead to the same protected corridor, they should be separated from each other by means of a self-closing fire door across the corridor and should lead to separate storey exits.

Diagram 2 illustrates the restrictions required for rooms provided with a single means of escape.

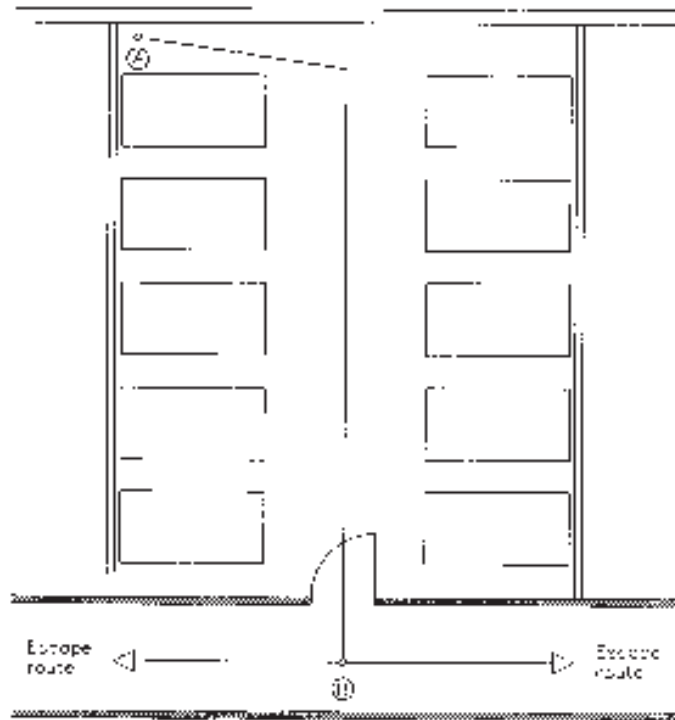
Diagram 2
Room with a single means of escape



TYPICAL FLOOR PLAN

KEY  30 minutes fire resisting construction
 Fire door FD 30 2

Notes

- (1) Maximum travel distance from A to B is 10 m.
- (2) Number of persons occupying a dormitory should not exceed 10.
- (3) Number of occupants in any other habitable room should not exceed 50.
- (4) See Section 4.3.4 for escape corridor provisions.
- (5) See Section 4.4.3 for number and location of escape stairways.
- (6) See Chapter 5 in relation to fire doors and structural fire precautions.

4.3.4 Escape Corridors

Corridors which form part of an escape route should be constructed in 30 minutes fire resisting construction. Doors opening onto escape corridors, other than a door from a toilet or bathroom which is not used for the storage of combustible materials and is separated from the remainder of the building by fire resisting construction, should be fire resisting and self-closing (see Chapter 5).

Escape corridors should be effectively sub-divided by self-closing fire doors at approximately mid-point between storey exits so as to restrict the spread of smoke along their length.

Dead-end corridors are corridors where escape is possible in only one direction. Except in a building permitted to be served by a single escape stairway (see Section 4.4.4), dead-end corridors which lead to a protected escape stairway should be arranged so as to allow access to an alternative storey exit, without having to pass through the stairway enclosure. The dead-end part of the corridor should be separated from the remaining section by fire doors, at a position which ensures that the door to the stairs enclosure is within the dead-end section (see Diagram 1).

The width of escape corridors should generally be not less than 900 mm. A lesser width may be acceptable, provided that any door which subdivides its length is not less than 750 mm, and there is adequate width for the purpose of evacuation.

4.4 Vertical Escape Routes

4.4.1 General

Vertical escape routes are those parts of the escape routes which lead from the upper storeys of the building to a place of safety in the open air at ground floor.

Vertical escape routes should be by way of stairways which are protected from fire by means of fire resisting construction. The protection is provided to the enclosure to the stairway at all storeys and additionally by the provision of protected lobbies, where required, between the stairs enclosure and the accommodation.

In some limited situations (see Section 4.4.7) an external escape stairway may be the only practicable way of providing an alternative means of escape from a building.

4.4.2 Protection of Vertical Escape Routes

The protection of vertical escape routes, by enclosing the stairways in fire resisting construction, is essential to protect the escape routes from smoke and fire. The protection of stairways also restricts the spread of fire between storeys. Guidance on fire resisting construction is contained in Chapter 5 of this Guide.

To restrict smoke entering a protected stairway, doors opening into it must be self-closing fire doors. In some situations it may also be necessary to provide a protected lobby between the stairs enclosure and the accommodation, for example in the case of a building which is served by a single stairway (see Section 4.4.4).

In general, doors from rooms should not open directly into escape stairways. Rooms should connect to the escape stairways only by way of protected corridors or protected lobbies. However, a toilet or bathroom which is not used for the storage of combustible materials but may contain a water heater and is separated from the remainder of the building by fire resisting construction, may connect directly to the stairs enclosure.

Circulation routes on a storey should be excluded where possible from escape stairways. Escape stairways should lead directly to a place of safety in the open air at ground floor level. The route from the base of the stairway to the final exit at ground floor level should be protected by means of fire resisting construction.

Storage of any kind should not be provided in escape stairways. This includes hot presses and storage cupboards which are places of special fire risk. The area under the staircase should not be used for the storage of combustible materials and signs to this effect should be clearly displayed. There are also restrictions on the location of some building services in escape stairways (see Chapter 6).

Escape stairways should have openable windows, to allow for ventilation of smoke which may enter it from the accommodation. Stairways which are not provided with openable windows should have an appropriate smoke ventilation facility, with a suitable means of opening, provided at the top landing of the stairway enclosure.

4.4.3 Number and Location of Escape Stairways

The number of escape stairways should be adequate to safely evacuate the building, if required, on the basis of any one stairway being unavailable for use on account of a fire. Escape stairways should be located so as to provide alternative escape routes and to reduce to a minimum the dead-end travel (see Section 4.3.2).

The number and location of escape stairways required will also be determined by the restrictions in travel distance indicated in Table 4.1.

4.4.4 Small Premises with Single Escape Stairway

In some small premises it may not be practicable to provide a second protected escape stairway or an external escape stairway. A single protected escape stairway may be adequate where all of the following conditions are met :

- (a) there is no storey with a floor level more than 10 m above ground level;
- (b) not more than 20 bed spaces are provided above the ground floor storey;
- (c) travel distances are within the limits for escape in one direction only (see Section 4.3.2);
- (d) the protected stairway is separated from all accommodation by means of fire resisting lobbies or protected corridors at all storey levels except at the top most level, and the stairway does not continue down to any basement or lower-ground storey (see Diagram 3);
- (e) in the case of a building with not more than two storeys (ground and first floor) a room, which is not a place of special fire risk, may open directly into the stairs enclosure where the travel distance from any part of the room to a place of safety does not exceed 20 m and the door between the room and the stairs enclosure is a self-closing fire door (see Diagram 4);
- (f) all habitable rooms have at least one openable window (minimum opening size of 850 mm high x 500 mm wide, with the bottom of the opening not more than 1100 mm and not less than 800 mm above

the floor level of the room) which is available for the purpose of escape or rescue; and

- (g) the fire detection and alarm system for the premises complies with the requirements for an L1 type system in accordance with *I.S. 3218 : 1989 : Code of Practice for Fire Detection and Alarm Systems for Buildings - System Design, Installation and Servicing* (see Section 5.6).

Diagrams 3 and 4 illustrate examples of small premises with a single escape stairway.

Diagram 5
Small premises with a single stairway (3 storey)

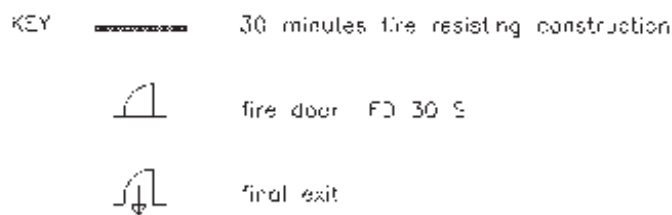
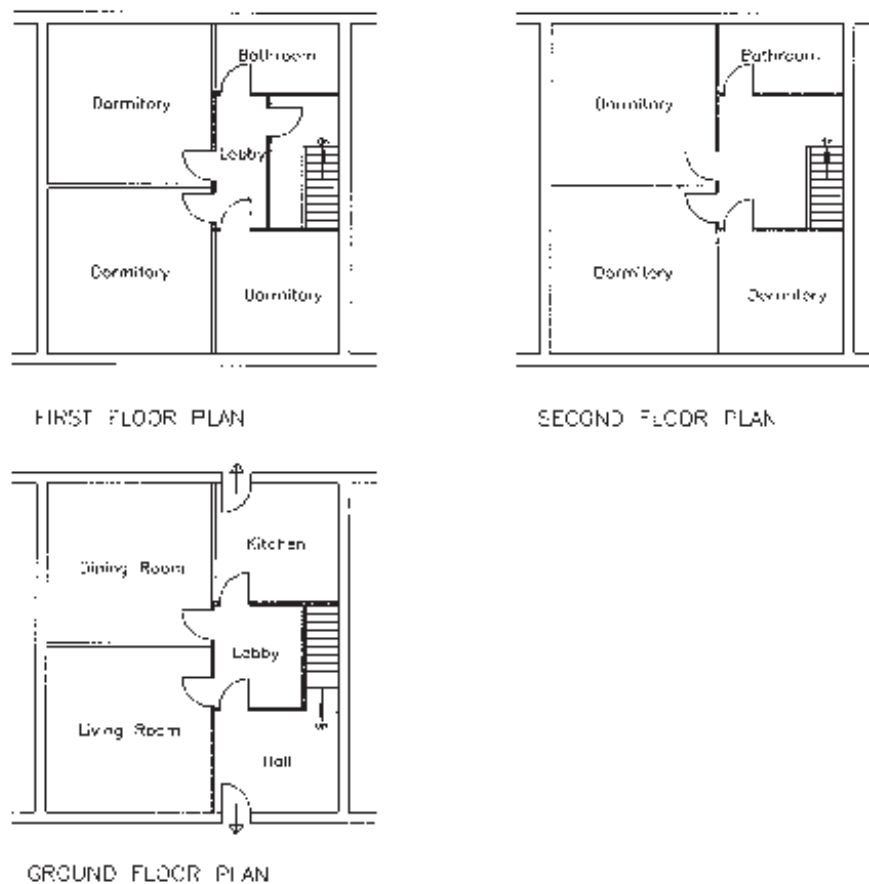



Notes

- (1) Conditions which apply to the premises served by a single escape stairway are outlined in Section 4.4.4.
- (2) Where no storey is more than 10 m above ground level and with not more than 20 bed spaces above the ground storey.
- (3) See Chapter 5 in relation to fire doors and structural fire precautions.

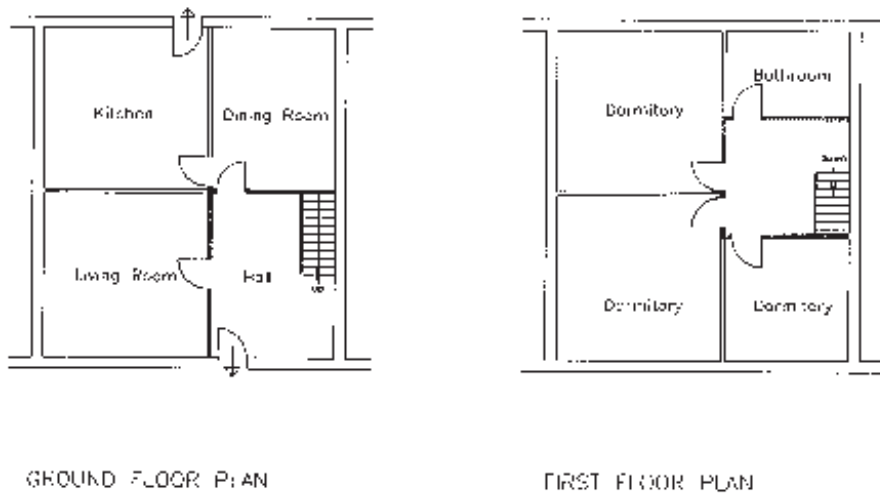
Diagram 4
 Small premises with a single stairway (2 Storey)



KEY

	30 minutes fire resisting construction
	fire door FD 30 S
	final exit

Notes

- (1) Conditions which apply to the premises served by a single escape stairway are outlined in Section 4.4.4.
- (2) Total travel distance does not exceed 20 m.
- (3) Not more than 20 bed spaces at first floor level.
- (4) See Chapter 5 in relation to fire doors and structural fire precautions.

4.4.5 Stairways serving Basements and Lower-Ground Floor Storeys

A stairway which is the only protected escape stairway in a building should not extend down to any basement storey. Where there is more than one protected stairway in a building, at least one should terminate at ground floor level.

Any permitted stairway which connects a ground floor to a basement or lower-ground floor storey should be a protected stairway.

Where an escape stairway extends to a basement or lower-ground floor storey, it should be separated from any accommodation at the lower level by a protected lobby or corridor and the section between the ground floor and basement or lower-ground floor storeys should be separated from that serving the upper storeys by a protected lobby or corridor.

4.4.6 Escape Stairways : General Provisions

The width of escape stairways will depend on the number of persons likely to use them but should not generally be less than 800 mm. Guidance on the width of escape stairways is contained in Technical Guidance Document B (Fire Safety) to the Building Regulations, 1997.

A stairway may be acceptable as an escape stairway where :

- (a) it is a protected stairway and leads directly to a place of safety at ground floor level;
- (b) the width of the stairway and dimensions of steps are adequate for the purposes of means of escape;
- (c) the stairway is of sound construction and is capable of affording safe passage for the users of the building; and

- d) the pitch of the stairway does not exceed 38° and is constant throughout its length and the number of treads in a flight is not more than 16 nor less than 3.

4.4.7 External Escape Routes

An external escape route is acceptable as an alternative means of escape only where :

- (a) a suitable alternative internal protected escape stairway can not be practicably provided; and
- (b) the height to the floor of the top storey does not exceed 10 m above ground level.

New external escape stairways should comply with Part K of the Building Regulations, 1997. Guidance as to how to comply with Part K of the Building Regulations is contained in Technical Guidance Document K (Stairways, Ladders, Ramps and Guards) to the Building Regulations, 1997.

External stairways should also comply with the following conditions and Diagram 5 illustrates these:

- (a) all doors affording access to the stairway should be fire resisting, unless it is located at the head of the stairway, leading downwards;
- (b) any part of the external walls or roofs within 1.8 m of, and 10 m vertically below, the flights and landings of a stairway leading downwards should be of fire resisting (minimum 30 minutes) construction; and
- (c) protection should be provided, by means of fire resisting construction, for any part of the building (including doors) within 3 m of the escape route from the foot of the stairway to a place of safety.

Diagram 5
External escape stairway

3 STOREY BUILDING

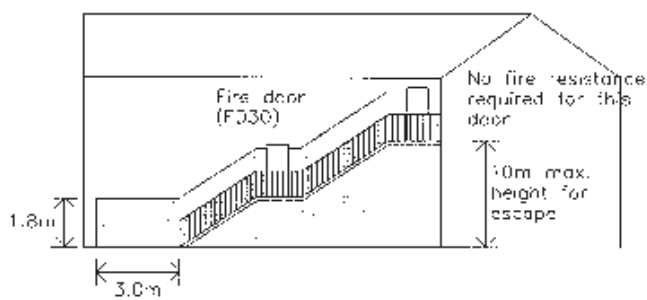

ELEVATION 1

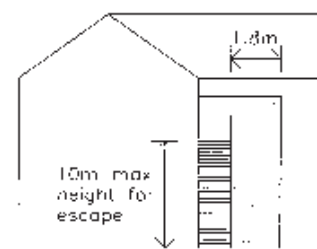

ELEVATION 2

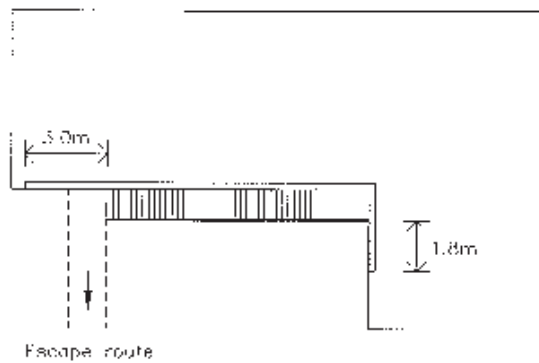

PLAN

Zone of fire resisting construction

4.4.8 Escape over Flat Roofs

Where an external escape route incorporates a part which is by way of a flat roof, the following conditions should be met:

- the escape route should be adequately defined, unobstructed and lit;
- the surface should be of a safe non-slip character and the route guarded with protective barriers (see Technical Guidance Document K (Stairways, Ladders, Ramps and Guards) to the Building Regulations, 1997);
- the escape route across the roof and its supporting structure should have a fire resisting rating as specified in Table 5.1; and
- any roof or wall openings that are not fire resisting should not be located within 3 m of the route.

4.4.9 Lifts

A lift which is designed for normal use only is not suitable for the purpose of means of escape in the event of fire. Persons who would be unable to use stairways for evacuation should be accommodated on the ground floor storey.

All lifts should be contained within an enclosure with fire resisting construction (see Chapter 5).

A protected lobby should be provided between lift doors and corridors. Where a lift is contained within a stairway enclosure, it should be so for its full travel and should not communicate directly with accommodation at any storey level.

In a single stairway building the lift should terminate at ground floor level. Lift machine rooms should be separated from the lift enclosure with fire resisting construction. Any openings for the operation of the lift should be as small as possible. Lift motor rooms

should not be used to provide storage or other use and should be provided with automatic smoke detection (see Section 4.6).

4.5 Escape Routes : General Provisions

4.5.1 Floor Surfaces on Escape Routes

The floors of corridors, lobbies, landings and stairways forming parts of escape routes should have non-slip even surfaces. Where ramps are being provided for use by physically handicapped persons, they should comply with Technical Guidance Document M (Access for Disabled People) to the Building Regulations, 1997.

4.5.2 Height of Escape Routes

Escape routes should have a minimum clear headroom of 2 m and should not have any obstructions or projections except any door frame below this height.

4.5.3 Doors on Escape Routes

All doors on escape routes should generally open in the direction of escape. Doors should not open across stairways, or obstruct the width required for escape of corridors, landings, or lobbies when open. However, doors serving rooms which accommodate less than 50 persons may open into the accommodation.

A fire resisting vision panel should be provided in fire doors which are located on corridors for the purpose of sub-division.

4.5.4 Door Fastenings

Exit doors should be readily and immediately openable at all times from the inside. They should not be dead-locked or fitted with barrel-bolts. The use of break-glass boxes containing keys for exit doors is not suitable. Fastenings should be of a type such as lever-handled latches or night latches that can be opened without use of a key.

Panic-bolt type locking mechanisms should be used on doors on escape routes which may be used by 50 or more persons and should comply with *BS EN 1125 : 1997 : Building hardware. Panic exit devices operated by a horizontal bar. Requirements and test methods*. Doors which are opened by means of panic bolts should have a sign "PUSH BAR TO OPEN" displayed on them.

Access to all sleeping accommodation should be available to staff, in the event of an emergency.

4.5.5 Assembly Points

All escape routes should discharge to a place of safety with clearly indicated and designated assembly points. These areas should be well clear of the building at positions which do not interfere with emergency operations.

4.6 Fire Detection and Alarm Systems

The provision of an appropriate fire detection and alarm system is an essential element of the fire safety measures in a hostel. It provides early warning of the occurrence of fire and thereby facilitates the activation of appropriate emergency procedures, including evacuation. Early detection also improves the chances of restricting the growth and spread of fire within the building by the use of first aid fire-fighting equipment, where safe to do so, and by early call-out of the fire services.

A fire detection and alarm system should be provided in all hostels. It should meet the requirements for an L1 type system complying with I.S. 3218. The system should incorporate automatic fire detection (heat or smoke type detectors, as appropriate) throughout the premises and suitably located manual activation facilities. An L1 type fire detection and alarm system requires automatic detection in escape routes, all rooms and other fire risk areas.

Large buildings should be divided into fire alarm zones, as required by the standard, which will facilitate identification of the alarm source. Control and indicating equipment

should be located in positions where there is maximum supervision. A procedure should be developed to ensure that the panel is attended immediately the alarm is raised. The fire warning system should be designed to be an integral part of the evacuation strategy.

It is essential that reliable means are established for ensuring that, when an alarm occurs, the fire brigade is called with the minimum of delay. This will normally be done by telephone. In large buildings consideration should be given to the provision of an automatic facility for this purpose.

The fire detection and alarm system should be designed, installed and maintained in accordance with the requirements of I.S. 3218 and certification to that effect should be kept on the Fire Safety Register. Management and staff should be familiar with the mode of operation of the fire detection and alarm system and of the user responsibilities in relation to periodic inspection, testing and maintenance, as outlined in the standard. A commissioning certificate in the form specified in the standard should be obtained on completion of any new or modified system. Existing systems may require to be examined to determine the extent of compliance with the recommendations of this Guide and remedial work undertaken where necessary.

4.7 Emergency Lighting

4.7.1 Introduction

In the event of failure of the electrical supply to the normal lighting, emergency lighting is necessary in a hostel to provide sufficient lighting to :

- indicate clearly and unambiguously the escape routes within the building and along external escape routes where necessary;
- provide illumination along escape routes to allow safe movement towards and through exits;

- ensure that fire alarm call points and fire-fighting equipment provided along escape routes can be readily located; and
- assist fire and emergency services in rescue, evacuation and fire-fighting operations.

4.7.2 Emergency Lighting Standards

Emergency lighting should be provided in all hostels in accordance with the recommendations of *I.S. 3217 : 1989 : Code of Practice for Emergency Lighting*.

Emergency lighting is normally provided by means of suitably located self-contained lighting units. Careful attention should be given to the position of emergency lighting units, to provide for the required level of illuminance and to indicate changes in direction and in level along escape routes.

There are different modes of operation for emergency lighting systems. "Maintained" and "combined" or "sustained" systems are illuminated at all material times i.e. when the building is occupied, while a "non-maintained" system is only illuminated on failure of the normal power supplies. Generally within a hostel, a combination of both these types will be provided, with the emergency lighting on the common escape routes (escape corridors, stairways), dining/cooking areas and the other common areas being illuminated at all material times.

The duration of the emergency lighting system should be not less than 1 hour. The levels of illuminance provided by the system should comply with values specified in *I.S. 3217*.

The emergency lighting system should be designed, installed and maintained in accordance with the requirements of *I.S. 3217*. Management and staff should be familiar with the mode of operation of the emergency lighting system and of the user

responsibilities in relation to periodic inspection, testing and maintenance, as outlined in the standard.

4.7.3 Completion of Emergency Lighting

A commissioning certificate in the form specified in that standard should be obtained on completion of any new or modified system. Existing systems may require to be examined to determine the extent of compliance with the recommendations of this Guide and remedial work undertaken where necessary.

4.8 Signposting of Escape Routes

Exit and directional signs should be provided on all escape routes. If the access route to a stairway is via a long or circuitous route, exit and directional signs may be required to indicate clearly the escape route. In multi-stairway buildings exit signs should be provided to indicate clearly the alternative escape routes available from each storey of the building. Directional signs should also be provided where alternative exit locations are not visible from any point in the common areas of the building.

Exit signs should be located where they are most likely to be seen and preferably, immediately above the exit opening. Directional signs should be fixed in conspicuous positions and wherever possible between 2 m and 2.5 m above floor level.

Attention is drawn to the Safety, Health and Welfare at Work (Signs) Regulations, 1995 (S.I. No 132 of 1995). Emergency escape signs, fire-fighting equipment and no smoking signs should be in accordance with these Regulations. Other signs may also be required for the purpose of these Regulations, but these are outside the scope of this Guide.

Chapter 5 Structural Fire Precautions

5.1 Introduction

Structural fire precautions in buildings are required to prevent premature structural failure and to limit fire spread. For these purposes, the following provisions are necessary :

- sub-division of the building into a number of fire compartments;
- elements of structure to be provided with appropriate fire resistance;
- compartmentation of places of special fire risk;
- restrictions to linings of walls and ceilings so as to limit their contribution to the development of fire and to have adequate resistance to the spread of fire along their surfaces;
- the provision of fire doors to limit the spread of fire and smoke; and
- limitation of fire spread at junctions between building components, service penetrations and in cavities.

Structural fire precautions are also necessary to protect the means of escape (see Chapter 4).

5.2 Compartmentation

The spread of fire within a building can be restricted by subdividing it into a number of fire compartments. This is achieved by the provision of compartment walls and floors of fire resisting construction. Places of special fire risk (see Section 5.6) should be separated from other accommodation by compartmentation.

The objective of compartmentation is to prevent the uncontrolled spread of fire throughout the building, thereby allowing more time for evacuation. It will also assist fire-fighting operations by the fire brigade. This is particularly important in the case of larger buildings.

All floors in hostels, not being the lowest floor of the building, should be constructed as compartment floors.

Compartment walls and floors and any doors in compartment walls are required to achieve an appropriate level of fire resistance (see Sections 5.4 and 5.9).

5.3 Elements of Structure

For the purpose of resistance to fire, the following elements are regarded as elements of structure :

- (a) any member forming part of the structural frame of a building or any other beam or column not being a member forming part of a roof structure only;
- (b) compartment floors and walls and walls separating buildings;
- (c) a load-bearing wall or load-bearing part of a wall; and
- (d) any structure enclosing a protected shaft or stairway.

5.4 Fire Resistance

The fire resistance of an element of structure is a measure of the ability of that element to withstand the effects of fire for a specified duration, when it is tested to a particular standard. The standard test methods normally employed are those contained in *BS 476 : Parts 20 - 24 : Fire tests on building materials and structures*.

The recommendations for fire resistance are intended to provide the structural elements with resistance to exposure to fire, for reasonable periods. The element of structure should either be :

- (a) constructed to the same specification as that which, if exposed to test by fire in accordance with BS 476 : Parts 20 - 24, would fulfil its function in relation to

load-bearing capacity, integrity and insulation for not less than the required duration; or

- (b) conform with one of the specifications set out in the Building Research Establishment Report "Guidelines for the construction of fire resisting structural elements" for the required periods of fire resistance.

The fire resistance of a door is a measure of its ability to withstand the effects of fire under specified test conditions, for a specified duration. The standard test methods normally employed are those contained in BS 476 : Parts 20 - 24.

Elements of construction should not generally be treated in isolation. The interaction of one element on another should not lessen the fire resistance for the composite construction. The junction of elements, such as walls and ceilings, may present points of weakness and care should be taken to ensure the integrity of such areas in fire conditions.

Guidance on increasing the fire resistance of existing timber floors is given in Building Research Establishment Digest Number 208.

Guidance on methods to increase the fire resistance of existing timber doors is available from the Timber Research and Development Association (see Section 5.9).

5.5 Fire Resistance for Elements of Structure

The fire resistance of the elements of structure in a building used as a hostel should not be less than the values indicated in Table 5.1 below. The tabulated fire resistance values (expressed in minutes) relate to the performance of the element of structure in a standard fire resistance test in terms of load-bearing capacity, integrity and insulation by reference to BS 476 : Parts 20 - 24. Limited amounts of non-insulated glazing are permitted on escape routes, provided these meet the criteria indicated in Table A4 of

Appendix A to Technical Guidance Document B (Fire Safety) to the Building Regulations, 1997.

Table 5.1

Fire Resistance of Structural Elements	
Location of Element	Fire Resistance (Minutes)
Buildings with not more than four storeys above ground level (ground storey and up to three storeys above the ground storey)	30
Buildings with more than four storeys above ground level	60
Basement, Lower-Ground storey	60
Enclosure to place of special fire risk	60
Enclosure to protected escape stairway :	
(a) not more than 4 storeys above ground level	30
(b) more than 4 storeys above ground level	60
Enclosure to escape corridor	30
Enclosure to small store room	30
Separation of ancillary shop, restaurants or bar from other accommodation	30

5.6 Places of Special Fire Risk

Areas which present a special fire risk should be compartmented by means of construction having a minimum fire resistance of 60 minutes. Examples of such areas include kitchens, laundry rooms, store rooms and

electrical switch rooms. Doors into such areas, except where they open directly to the outside, should have a fire resistance of 60 minutes, be fitted with self-closing devices, and should not be held permanently open.

Small store rooms, including linen presses, should be separated by means of 30 minutes minimum fire resisting construction, with 30 minutes self-closing fire doors.

A central-heating boiler should preferably be located in a separate outside building, but if it is within the building it should open directly to the outside and should ideally not communicate directly with other accommodation.

Places of special fire risk should be provided with automatic fire detection, connected to a fire alarm system for the building (see Section 4.6).

5.7 Construction Details

5.7.1 Junctions

Junctions between elements of construction, cavities, pipe-ducts and lifts frequently constitute points of weakness for fire spread and should be checked carefully. Junctions between building components should not be such as to transfer fire from one side to the other. Suitable fire-stopping should be provided in these areas.

5.7.2 Cavities

Cavities and hidden spaces, such as hollow walls and suspended ceilings, can provide a route for fire spread between rooms and throughout buildings. Cavity barriers should be provided to restrict the spread of smoke and fire within cavities. Large cavities may also need to be protected by automatic fire detection. Where cavity barriers and fire-stopping are being provided, these should generally comply with the recommendations contained in Sections 3.3 and 3.4 of Technical Guidance Document B (Fire Safety) to the Building Regulations, 1997.

5.7.3 Cables, Pipes, Ducts and Flues

Cables, pipes, ducts and flues which penetrate compartment walls, floors, protected enclosures or cavity barriers can also be potential points of weakness in fire. Such penetrations should be protected by fire-stopping so that the fire resistance of the element through which it passes is not impaired.

Ventilation ductwork should be provided with dampers as indicated in *BS 5588 : Part 9 : 1989 : Code of practice for ventilation and air conditioning ductwork*.

5.8 Wall and Ceiling Finishes

5.8.1 Fire Performance Requirements for Wall and Ceiling Linings

Wall and ceiling linings should have adequate resistance to spread of flame over their surfaces and should not contribute significantly to the development of a fire in a room or compartment. The surface of walls and ceilings should meet the fire performance indicated in Table 5.2 below for the locations indicated. Parts of walls in a room may have a lower classification than indicated in Table 5.2 (but not less than Class 3) provided these areas are restricted to half the floor area of the room or 20 m² (divided into 5 m² sections separated from each other by 2 m), whichever is the lesser.

Table 5.2

Performance of Wall and Ceiling Linings	
Location of wall or ceiling linings	Performance
Circulation spaces, including protected corridors, protected lobbies and protected stairways; toilets and bathrooms opening onto protected escape routes	Class 0
Habitable rooms exceeding 30 m ² in area	Class 0
Places of special fire risk	Class 0
Bedrooms or other habitable rooms not exceeding 30 m ² in area.	Class 1
Toilets, bathrooms and small rooms not exceeding 4 m ² in area	Class 3

5.8.2 Fire Performance Criteria

In Table 5.2, the surface spread of flame performance is by reference to the test method specified in *BS 476 : Part 7 : 1997 : Method of test to determine the classification of the surface spread of flame of products*, under which a material may be Class 1, 2 or 3, where Class 1 is the highest performance. To restrict the use of materials which ignite easily or which produce a high rate of heat release when ignited, "fire-propagation" indices, by reference to the method of test specified in *BS 476 : Part 6 : 1989 : Method of test for fire propagation for products*, are employed. Index of performance (I) relates to the overall test performance, whereas sub-index (i) is derived from the first three minutes of the test. Alternatively the performance can be related to combustibility, non-combustible or limited combustibility (see Appendix H).

The highest product performance classification, based on the above criteria, is Class 0. This is achieved if a material or the surface together with its substrate of a composite product is either :

- (a) composed throughout of materials of limited combustibility; or
- (b) a Class 1 material which has a fire propagation index (I) of not more than 12 and sub-index (i) of not more than 6.

5.9 Fire Doors

5.9.1 Provision of Fire Doors

Fire doors are provided to restrict the spread of fire and smoke in a building and form an important part in the defence against fire. They are provided in openings to compartment walls and the enclosures of protected stairways and lifts. They are also provided along and across protected escape routes (see Chapter 4). The provision of fire doors in hostels should be in accordance with Table 5.3 below.

Table 5.3

Provision of Fire Doors	
Location of fire doors	Type of fire door
A door forming part of the enclosure to a protected stairway, a protected lobby or a protected corridor.	FD30S
A door from a bedroom or dormitory to a protected escape corridor.	FD30S
A door sub-dividing a protected corridor.	FD30S
A door to a small store room.	FD30S
A door in a wall separating an ancillary shop, restaurants or bar from other accommodation.	FD30S
Enclosure to place of special fire risk	FD60S

Note : Door types FD30S and FD60S denote fire doors having minimum periods of fire resistance of 30 and 60 minutes respectively and the doors are provided with cold smoke seals.

5.9.2 Performance of Fire Doors

A fire door includes the door frame and associated ironmongery, such as hinges, locks, catches, seals and door-closures. The complete assembly, often referred to as a fire doorset, constitutes a fire door. The fire resistance of a fire door must be achieved, when it is part of a doorset, in its location within a building. The performance of fire doors is an important element in the fire safety provisions of a building. It is critical therefore that a fire doorset is installed correctly and in accordance with the relevant test certification.

Periods of fire resistance relate to performance in terms of integrity by reference to BS 476 : Parts 20 - 22. The suffix "S" denotes an appropriate cold smoke seal between the door and door frame. These doors should have leakage rates not exceeding 3 m³/m/hour at the heads and jambs.

New fire doors should be selected and installed in accordance with the following standards :

- BS 8214 : 1990 : Code of practice for fire door assemblies with non-metallic leaves; and
- BS : PD 6512 : Part 3 : 1987 : Guide to the fire performance of glass.

It is important that fire doors as installed in the building are in accordance with the relevant test certificate which demonstrates that they will meet the required performance.

Non-insulated fire resisting glazing may be incorporated into a fire door in accordance with the limitations as set out in Table A4 to Appendix A of Technical Guidance Document B (Fire Safety) to the Building Regulations, 1997.

The upgrading of existing doors to achieve the performance requirements for a fire door may be feasible in some cases. This should only be undertaken in accordance with tested and approved methods, such as the Timber Research and Development Association's Wood Information Sheet : Section 1 : Sheet 32, "Fire resisting doors by upgrading".

5.9.3 Closing Devices for Fire Doors

Fire doors (except to a cupboard or service duct) should be fitted with self-closing devices, which are capable of closing the doors from the fully-open position, with any latches fitted.

Where it is necessary to hold fire resisting doors in the open position e.g. doors across a corridor, this should only be done by means of electro-magnetic type devices linked to an automatic fire detection and alarm system. Any hold-open systems should incorporate an automatic release mechanism complying with *BS 5839 : Part 3 : 1988 : Specification for automatic release mechanisms for certain fire protection equipment*. The automatic release mechanism should release the door to close automatically in the event of any one of the following :

- (i) the detection of smoke by a detector on the fire detection and alarm system which is located adjacent to the door;
- (ii) the failure of the mains power supply;
- (iii) the operation of the manual or automatic fire alarm system; or
- (iv) the operation of any timing devices installed for that purpose.

Automatic door releases should be provided with a ready means of manual operation from a position at the door.

Fire doors (except where held open by a hold-open device complying with the above) should be marked, at about eye-level, with the appropriate fire safety sign to the effect that they should be kept closed when not in use.

5.9.4 Markings for Fire Doors

Fire doors (excepting bedroom/dormitory doors) should be marked at about eye level with the appropriate fire safety sign complying with *BS 5499 : Part 1 : 1990 : Specification for fire safety signs*, according to whether the door is :

- to be kept closed when not in use;
- to be kept locked when not in use; or
- held open by an electro-magnetic device.

Fire doors to cupboards and to service ducts should be marked on the outside; all other fire doors should be marked on both sides.

All new fire doors should be permanently identified in accordance with *BS 8214 : 1990 : Code of practice for fire door assemblies with non-metallic leaves*, indicating the period of resistance, manufacturer, and other pertinent details.

Chapter 6 Building Services

6.1 General

Building services are potential sources of fire, and equipment associated with them should be installed and maintained in accordance with the relevant standards and codes of practice. The importance of correct installation is emphasised because these services are often concealed above ceilings and in ducts and any fire caused by them is unlikely to be discovered for some time.

6.2 Electrical Services

6.2.1 Electrical Installation

The electrical installation comprising wiring, sockets, switches, distribution boards and other equipment should be installed, fitted and maintained in accordance with the Electro-Technical Council of Ireland (ETCI) "National Rules for Electrical Installations - ET 101". The completion certificate for the installation should be kept on the Fire Safety Register.

The electrical installation should be inspected regularly, tested and an appropriate entry made in the Fire Safety Register. Existing installations may need to be upgraded. It is important that all replacement, upgrading, extensions and repairs to the electrical installation are carried out in accordance with the ETCI Rules and an appropriate entry made in the Fire Safety Register. Sufficient socket outlets should be provided for all the electrical appliances in use. Defective installations should be replaced or remedied in accordance with the ETCI Rules.

6.2.2 Electrical Appliances

Electrical appliances should conform with a standard appropriate at the time of manufacture such as the relevant parts of *I.S. 205 : Part 1 : 1980 : General Requirements*. Commercial electrical catering equipment should comply with the relevant parts of *BS 5784 : Safety of electrical commercial catering equipment*. Electrical equipment supplied through

permanent cables should have an isolator on the supply line.

All electrical appliances should be inspected and serviced on a regular basis and an appropriate entry made in the Fire Safety Register.

6.3 Gas Services

6.3.1 Natural Gas and LPG Installations

All gas installations, storage tanks, pipe lines, gas burning flues and other equipment should be installed, fitted and maintained in accordance with the appropriate standards and codes of practice (see Appendix I).

All gas installations should be inspected at regular intervals and an appropriate entry made in the Fire Safety Register. It is important that all extensions and repairs to the gas installation are carried out in accordance with the relevant codes and standards and an appropriate entry made in the Fire Safety Register.

As a general principle, gas installations, including pipe-work, should not be positioned in escape routes. Portable gas cylinders/cartridges both full and used should be stored in an external well ventilated store in accordance with *I.S. 3213 : 1987 : Code of Practice for the Storage of LPG Cylinders and Cartridges*. The bulk storage of LPG should comply with *I.S. 3216 : 1988 : Code of Practice for the Storage of LPG at Fixed Installations*. Two shut-off safety valves should be installed on a piped gas supply, one inside and the other outside the building. These valves should be manually or automatically operated and their location, purpose and mode of operation should be clearly indicated. Gas cylinders while in use should not be located near basements, building openings or un-trapped drains, see *I.S. 813 : 1996 : Domestic Gas Installations* or *I.C.P.4 : 1989 : Non-Domestic Installations for Manufactured and Natural Gas (Edition 2)*, as appropriate.

Attention is drawn to Dangerous Substances (Storage of Liquefied Petroleum Gas) Regulations, 1990 (S. I. No 201 of 1990). These Regulations apply where the storage of LPG is in an amount greater than 70 kilograms or the total storage capacity is greater than 160 litres.

6.3.2 Gas Appliances

All gas appliances should conform with an appropriate standard in use at the time of manufacture. Gas-burning appliances should be installed, fitted and maintained in accordance with the appropriate standards and codes of practice (see Appendix I). Gas appliances should be inspected and serviced at regular intervals and an appropriate entry made in the Fire Safety Register.

6.4 Heating Systems

6.4.1 Space Heating

Space heating should preferably be provided by means of a central heating hot water system using a solid fuel, oil or gas burning appliance installed to an appropriate standard. Boiler appliances for such systems should be separated from the rest of the building by fire resisting construction, and access to them should be from outside the building. Fuel supplies to oil burners should comply with *BS 5410 : Code of practice for oil firing : Part 1 or Part 2*, as appropriate and be fitted with a fire valve. Gas supplies to burners should be fitted with an automatic cut-off valve linked to both a gas and a heat detector. Boilers in basements or those which are not accessible from the open air may also need to be protected by a foam inlet valve complying with *BS 5306 : Part 1 : 1976 : Hydrant systems, hose reels and foam inlets*. Gas supplies should comply with the relevant standards indicated in Section 6.3 above.

6.4.2 Heating Appliances

Individual heating appliances, where provided, should be fixed in position and should be of a type

which does not have an exposed flame or heating element which could provide an ignition source. Heating appliances should be properly maintained in safe working order.

Where open fires are used, appropriate spark-guards should be provided and chimney flues should be regularly cleaned. Fuel should not be stored indoors and should only be placed on fires by a member of staff. Care should be taken to ensure that open fires are properly supervised and are safely secured for the night time.

6.5 Ventilation Systems

Ventilation and air-conditioning systems should not be capable of spreading fire and smoke within the building and should comply with an appropriate standard such as *BS 5720 : 1979 : Code of practice for mechanical ventilation and air conditioning in buildings*. Ventilation and air conditioning ductwork should comply with *BS 5588 : Part 9 : 1989 : Code of practice for ventilation and air conditioning ductwork*.

Chapter 7 Furnishings and Fittings

7.1. General

The flammability and properties of the furnishings and fittings in a building are important in determining the ease with which a fire can start, and also its rate of development. The products of combustion of furnishings and fittings may impinge on the safety of the occupants of the building. Generally, furnishings and fittings are made of materials which are combustible, and only a degree of safety can be attained by utilising components based on resistance to ignition characteristics, and low or non-toxic combustion properties.

7.2 Seating

Seating can be ignited by a small ignition source such as a cigarette or match. It can also be ignited by ignition of materials on, underneath or adjacent to it. As a general functional requirement all seating should be constructed of materials which cannot be easily ignited by such small ignition sources.

Foam filling materials used in seating and cushions should comply with *I.S. 419 : 1988 : Fire Safety Requirements for Components of Furniture* - Clause 2. Non-foam and Composite filling materials should comply with Clause 3.1 of the same standard.

Upholstery in seating should, when tested in accordance with *I.S. 254 : 1983 : Flame Resistance Requirements for Upholstery*, pass the smouldering cigarette test and ignition source number 5 test.

Rigid plastic seating should, when tested in accordance with *I.S. 254*, modified as in Appendix A of the Code of Practice for Fire Safety of Furnishings and Fittings in Places of Assembly, pass the smouldering cigarette test and ignition source number 5 test. If upholstered, the seating should also comply with the standards indicated above for upholstered seating.

Permanent covers which form part of the upholstery of an item of seating should comply with Clause 4 of *I.S. 419*.

The covering materials of upholstered seating should be maintained free of cuts and tears and filling materials should not be exposed.

7.3 Vertical Hangings

As a general functional requirement vertical hangings should be made from materials which do not easily ignite or which if ignited transmit flame for a short distance only. Existing materials may be upgraded by appropriate processes to achieve the desired standards. Only appropriate processes which do not damage inherent or upgraded flammability properties should be used for cleaning or laundering vertical hangings.

Curtains and lining fabrics used should comply with the requirements for Type B of *BS 5867 : Part 2 : 1980 : Flammability requirements* when subjected prior to the test to the appropriate washing procedure specified in *BS 5651 : 1978 : Cleansing and wetting procedures for use in the assessment of the effect of cleansing and wetting on the flammability of textile fabrics and fabric assemblies*.

Materials used in the production of blinds should comply with the designation of "flameproof" in *BS 3120 : 1959 : Specification for performance requirements of flameproof materials for clothing and other purposes*, when subjected prior to the test to the appropriate washing procedure in accordance with *BS 5651*.

7.4 Floor Coverings

Floor coverings may be ignited by flaming and/or smouldering ignition sources i.e. matches, cigarettes, etc., and may assist fire spread to furniture and fittings. As a general functional requirement, floor coverings should not ignite easily and if ignition does occur the fire should not spread.

All textile floor coverings e.g. carpets should be tested according to the method specified in *BS 4790 : 1987 : Method for determination of the effects of a small source of ignition on textile floor coverings (hot metal nut method)*, and

assessed according to *BS 5287 : 1988 : Specification for assessment and labelling of textile floor coverings to BS 4790.*

The use of textile floor covering with a 'low radius of effects of ignition' is recommended. Carpets are not recommended for use in a vertical plane to a height exceeding 100 mm from the floor, and should not be used as wall linings.

7.5 Bedding

Beds may be ignited by flaming and/or smouldering ignition sources such as matches, cigarettes, radiant heaters or by electric blankets. As a general functional requirement bedding materials should not easily ignite and, if ignition does occur, fire should not spread.

All new mattresses provided should resist ignition sources 0, 1 and 5 when tested to Section 2 of *BS 6807 : 1996 : Assessment of the ignitability of mattresses, upholstered divans and upholstered bed bases with flaming types of primary and secondary sources of ignition.*

7.6 Miscellaneous

Waste receptacles can pose a hazard if combustible materials in them are ignited accidentally. They should be made from materials which will not burn. In public areas, waste-paper receptacles with separate ashtray top should be used.

7.7 Test Certificates

Test certificates (indicating compliance with requirements) should be provided by the suppliers of new or replacement items of furnishing described above to the owners/occupiers of hostels. These certificates should be kept for inspection at the premises. Where there are a number of identical items of the same type, one test certificate will suffice.

Chapter 8 Fire-Fighting Equipment

8.1 General

Strategic positioning of portable extinguishing equipment throughout a hostel enhances the fire protection of the building, by enabling an attack to be made on a developing fire in its early stages by the occupants and staff. Portable extinguishing equipment does not itself offer protection, unless persons are trained in its proper, safe, and effective use.

Fire-fighting equipment should be provided using :

- portable fire extinguishers;
- hose reels; and
- fire blankets.

Signs indicating the location of fire-fighting equipment should be in accordance with Safety, Health and Welfare at Work (Signs) Regulations, 1995 (S.I. No 132 of 1995).

8.2 Portable Fire Extinguishers

Water type portable fire extinguishers should be provided in sufficient numbers to give adequate cover on each floor. The number will depend on the size and layout of the building. On each floor there should be one water type extinguisher of 9 litres capacity for every 100 m² of floor area or part thereof. Two extinguishers of 4.5 litres capacity may be used instead of one of 9 litres. At least one extinguisher suitable for fires in electrical equipment should also be provided for each floor. This may be a carbon dioxide or general purpose (ABC) dry powder extinguisher.

Portable fire extinguishers which are provided in hostels should be manufactured to an appropriate standard, such as *I.S. 290 : 1988 : Portable Fire Extinguishers, I.S./EN 3 : 1996 : Portable Fire Extinguishers* or equivalent and be installed in accordance with the recommendations of *I.S. 291 : 1986 : The Use, Siting, Inspection and Maintenance of Portable Fire Extinguishers* or equivalent. They should comply with the following general requirements :

- they should generally be located in conspicuous positions on brackets, stands or purpose-made housings where they can be readily seen and easily available for use;
- the most suitable locations for extinguishers are near to room exits, escape corridors, escape stairways, lobbies and landings; extinguishers should not be positioned away from exits unless they are necessary to cover a particular hazard;
- extinguishers should be readily accessible and available for immediate use at all times, and should be so situated that it is not necessary to travel more than 20 m to reach an extinguisher;
- extinguishers should be mounted so that the carrying handle of large, heavy extinguishers is not more than 1 m from the floor, and smaller extinguishers should be mounted so that the handle is not more than 1.5 m from the floor;
- the operation of extinguishers is affected by temperature, and they should not be exposed to storage temperatures outside the operational range marked on the extinguisher; in particular, extinguishers should not be placed over or close to heat producing appliances; and
- it is necessary that fire extinguishers are regularly inspected, maintained and recharged in accordance with the appropriate standards; fire extinguishers that comply with I.S./EN 3 should be inspected and maintained in accordance with I.S. 291, and other extinguishers with *BS 5306 : Part 3 : 1985 : Code of practice for selection, installation and maintenance of portable fire extinguishers* and appropriate entries made in the Fire Safety Register.

8.3 Hose Reels

Hose reels for fire-fighting should be installed in larger premises in addition to water type fire extinguishers as they provide a continuous flow and allow for a longer period for fire-fighting. The number will depend on the size and layout of the building. In general where a compartment exceeds 400 m² in floor area hose reels should be provided.

Hose reels should comply with the requirements of *I.S./EN 671-1 :1995 : Fixed Fire-Fighting Systems Hose Reels with Semi-Rigid Hose*, and be installed to *BS 5306 : Part 1 : 1976 : Hydrant systems, hose reels and foam inlets*.

The distribution of hose reels should be such that a nozzle can be taken to within 6 m of the most remote part of the compartment. Hose reels should be situated in prominent and accessible positions adjacent to escape routes. They should not form obstructions on escape routes and should be installed in recessed cabinets if necessary.

8.4 Fire Blankets

At least one light duty fire blanket to *BS 6575 : 1985 : Specification for fire blankets* or *I.S. 415 : 1988 : Fire Blankets*, should be fitted in kitchens for dealing with small cooking fires.

8.5 Places of Special Fire Risk

At least one portable fire extinguisher (carbon dioxide, dry powder or other type) suitable for electrical and flammable liquid fires should be provided to deal with each place of special fire risk, e.g. kitchen, laundry and central heating boiler room. These should be situated near the risk concerned, but not so close as to be inaccessible in case of fire. If the place of special risk is contained in a confined space or small room, it is generally advisable to place the extinguisher outside that space or room.

Large cooker hoods in kitchens should be fitted with an appropriate automatic extinguishing system i.e. CO² or halon replacement.

Where an automatic fire extinguishing system is installed it should be maintained in accordance with the appropriate standards.

Chapter 9 Access and Facilities for the Fire Service

9.1 General

Facilities should be available at hostels to enable effective rescue and fire-fighting to be carried out in the event of a fire on the premises. Fire service response will also be enhanced where familiarisation visits to the premises by the fire brigade have been conducted (see Section 3.10).

For effective fire service response to a fire in a hostel, there should be reasonable access to the building for fire appliances. In some situations, such as in the case of large buildings or where there are large numbers of occupants, and where the circumstances so warrant, special facilities may need to be provided to assist the fire service. These may include dry-rising mains for high buildings and in some cases fire-fighting lifts, to facilitate effective rescue and fire-fighting operations. Areas of special fire risk such as boiler rooms may need special facilities such as foam inlets to be provided. There should also be access to reasonable sources of water for fire-fighting on or adjacent to the site.

9.2 Access

In the event of an outbreak of fire in a hostel, ease of access to the perimeter of the building for fire brigade appliances is important. This will greatly facilitate early commencement of fire-fighting and rescue operations. Access is required to within a reasonable distance of the main entrance of the building and in larger buildings access to a number of points on the building perimeter is desirable. In the case of high buildings, access may be required for high-reach appliances to one or more elevations of the building. Gateways, access roadways and parking areas should be of adequate width and carrying capacity to facilitate access. It is recommended that access facilities be discussed with the relevant fire authority.

It is important that access is not restricted or obstructed by parking along access roadways and in areas which may be designated to be kept clear for fire (and emergency) appliances.

9.3 Facilities for the Fire Service

Facilities for the fire service in a hostel will depend on the size and height of the building and the number of occupants. In very many cases, no special facilities will be required.

Where the floor of any storey is more than 20 m above the ground floor, a dry-rising internal fire main, which is used to facilitate the provision of water for fire-fighting on the upper floors, will be required. Where there are boiler rooms without external access in basement areas, it is normal to provide a foam inlet pipe to facilitate fire-fighting in these areas.

Access to the building for fire-fighting personnel will generally be by way of the normal entrance and exit facilities but in some exceptional cases, the provision of specially equipped lifts may be warranted. Familiarisation visits by the fire brigade (see Section 3.10) will allow an assessment of any such facilities to be made.

A supply of water should be readily available to enable the commencement of fire-fighting operations, without undue delay. Water for fire-fighting, in addition to those quantities carried on fire brigade appliances, is available by way of a number of possible sources as follows :

- hydrants on external water mains, which may be provided by the local authority in public areas, or private mains within the grounds of the hostel;
- static storage facilities, where provided for this purpose; or
- other suitable sources such as swimming pools, rivers, canals, ponds, etc., where adequate access for pumping appliances is available, and which are within a reasonable distance of the hostel.

Glossary

The following terms or expressions, where they are used in the Guide, have the meaning assigned to them below unless otherwise stated in the text.

Basement storey : a storey, the floor of which is situated at such a level or levels that some point on its perimeter is more than 1.2 m below the level of the finished surface of the ground adjoining the building in the vicinity of that point.

Cavity : any space enclosed by the elements of a building, including a suspended ceiling, or contained within an element other than a room, cupboard, circulation space, protected shaft or the space within a flue, chute, duct, pipe or conduit.

Cavity barrier : construction provided to close a cavity or other concealed space against fire penetration or to restrict the movement of smoke or flame within such a space.

Circulation space : a space, mainly used as a means of access or egress, between any room and a final exit door from the building, including corridors, lobbies and stairway enclosures.

Compartment : a part of a building comprising one or more rooms, a storey or part of a storey, constructed to limit the spread of fire to or from another part of the building.

Duct : an enclosed space provided for the introduction or distribution of services in a building.

Dormitory : a room providing sleeping accommodation for more than four persons.

Escape route : a route by which a person may reach a place of safety, and in relation to any point in a building, a route from that point to a place of safety.

Final exit : the termination of an escape route from a building giving direct access to a place of safety such as a street, passageway, walkway, or open space situated so as to ensure that persons are no longer in danger from fire or smoke.

Fire door : a door, together with its frame and ironmongery, as installed in a building, which is intended to resist the passage of fire and/or gaseous products of combustion, which is capable of meeting specified fire performance criteria for a specified duration.

Fire hazard : the potential for loss of life or injury in the event of fire.

Fire protection : design features, forms of construction, components, systems or equipment in a building, provided to reduce the fire hazard to persons and property by detecting, extinguishing or containing fire.

Fire resisting construction : construction or elements of construction which are intended to meet specific test criteria under specified fire exposure conditions for a specified duration.

Fire risk : the probability of a fire occurring.

Fire-stopping : a seal provided to close an imperfection of fit or design tolerance between elements, components, or construction so as to restrict the penetration of smoke and flame.

Habitable room : any room in a building, with the exception of any utility room, store room, bathroom, or toilet.

Ignition source : heat source or flames which will cause the ignition of combustible materials.

Place of special fire risk : kitchens, store rooms, laundry rooms, boiler rooms, switchgear rooms and fuel stores

Place of safety : a place in which persons are in no danger from fire.

Protected lobby/corridor : a circulation area consisting of a lobby or corridor enclosed with fire resisting construction and forming part of an escape route, or affording additional protection to an escape route.

Protected route : an escape route within a building leading to a final exit which is enclosed by fire resisting construction or an external wall.

Protected shaft : a shaft which enables persons, air or things to pass between different compartments, enclosed by fire resisting construction

Protected stairway : a stairway, including any hall or space between the foot of the stairs and the final exit, which is adequately protected from fire in the accommodation through which it passes by fire resisting construction and discharges through a final exit to a place of safety.

Services : installations for the introduction into and distribution within a building of water, air, gas, liquid fuel, electricity, telecommunications, heat or other sources of energy and installations for fire protection.

Storey : any of the parts into which a building is divided horizontally above or below ground level but excluding any structure situated above the level of the roof or in the roof-space, or below the level of the lowest floor, which is intended for the protection of a water tank, or lift motor room, or similar use and is not used for habitable purposes or as a store room.

Storey exit : a final exit or a doorway giving direct access to a protected stairway or external escape route.

Travel distance : the actual distance to be travelled by a person from any point within the floor area to the nearest storey exit having regard to the layout of walls, partitions and fittings.

Appendix A

Fire Services Act, 1981

The following is a brief outline of the main provisions of the Fire Services Act, 1981 as it relates to hostels. It is not intended to be a legal interpretation of the Act.

A.1 Legal Responsibilities

Section 18(2) of the Fire Services Act imposes a duty on persons having control over certain premises, including hostels, to

"take all reasonable measures to guard against the outbreak of fire on such premises, and to ensure as far as is reasonably practicable the safety of persons on the premises in the event of an outbreak of fire."

Section 18(3) of this Act imposes a duty on every person on such premises, including guests and visitors, to

"conduct himself in such a way as to ensure that as far as is reasonably practicable any person on the premises is not exposed to danger from fire as a consequence of any act or omission of his".

A.2 Penalties

The Act provides for substantial penalties with fines of up to ten thousand pounds (£10,000) and/or two years imprisonment for persons convicted on indictment of an offence under the Act.

A.3 Fire Safety Notices

Under Section 20 of the Act, a fire authority may serve a fire safety notice on the owner or occupier of a "potentially dangerous building".

A "potentially dangerous building" is defined in Section 19 of the Act as "any building which would, in the event of a fire occurring therein, constitute a serious danger to life" for any of the reasons outlined in that section.

A fire safety notice may prohibit the use of a building (or part of it) and may require the owner or occupier to carry out specified fire precautions in that building. There is provision in Section 21 of the Act for a person on whom a fire safety notice is served to appeal against the notice in the District Court.

In a situation of serious concern about fire safety, a fire authority may apply, under Section 23 of the Act, to the High Court for an order to restrict or prohibit use of such a building.

It is an offence under the Act to fail to comply with the terms of a fire safety notice, and penalties similar to those outlined above may be imposed on a person convicted of such an offence.

A.4 Powers of Inspection

Section 22 of the Act gives powers of inspection to any "authorised person" (authorised by a fire authority). It is an offence under Section 22(6) to :

- refuse entry, at any reasonable time, to an authorised person, in the exercise of his duty;
- obstruct or impede an authorised person;
- fail or refuse to give information which a fire authority or an authorised person is entitled to require; or
- provide false or misleading information to a fire authority or an authorised person.

An authorised person should be in a position to produce satisfactory identification, if so requested.

Appendix B

Building Control Act, 1990

The following Regulations, made under the above Act, are relevant to new works carried out in existing hostels :

- Building Control Regulations, 1997 (S.I. No. 496 of 1997); and
- Building Regulations, 1997 (S.I. No. 497 of 1997).

Building Regulations, 1997 - Second Schedule : Part B (Fire Safety)

B1 Means of escape in case of fire

A building shall be so designed and constructed that there are adequate means of escape in case of fire from the building to a place of safety outside the building, capable of being safely and effectively used.

B2 Internal fire spread (linings)

For the purpose of inhibiting the spread of fire within a building, the internal linings :

- (a) shall offer adequate resistance to the spread of flame over their surfaces; and
- (b) shall have, if ignited, a rate of heat release which is reasonable in the circumstances.

B3 Internal fire spread (structure)

- (1) A building shall be so designed and constructed that, in the event of fire, its stability will be maintained for a reasonable period.
- (2)
 - (a) A wall common to two or more buildings shall be so designed and constructed that it offers adequate resistance to the spread of fire between those buildings.
 - (b) A building shall be sub-divided with fire resisting construction, where this is necessary to inhibit the spread of fire within the building.
- (3) A building shall be so designed and constructed that the unseen spread of fire and smoke within concealed spaces in its structure or fabric is inhibited where necessary.
- (4) For the purposes of sub-paragraph 2(a), a house in a terrace and a semi-detached house are each to be treated as being a separate building.

B4 External fire spread

The external walls and roof of a building shall be so designed and constructed that they afford adequate resistance to the spread of fire to and from neighbouring buildings.

B5 Access and facilities for the fire service

A building shall be so designed and constructed that there is adequate provision for access for fire appliances and for other such facilities as may be reasonably required to assist the fire service in the protection of life and property.

Alterations and Extensions

The Building Regulations apply to a material alteration of an existing building (Article 11 of the Building Regulations, 1997) :

11(1) Subject to Articles 3 and 8, these Regulations apply -

- (a) to all works in connection with the material alteration or extension of an existing building (whether or not such building was erected before the operative date); and
- (b) to every part of a building affected by works referred to in paragraph (a) but only to the extent of prohibiting any works which would cause a new or greater contravention, in such building, of any provision of these [Building] Regulations.

(2) For the purposes of this article, "material alteration" means an alteration (other than a repair or renewal) where the work, or any part of the work, carried out by itself would be subject to a requirement of Part A (Structure) or Part B (Fire Safety) of the Second Schedule [to the Building Regulations].

Technical Guidance Document B (Fire Safety) to the Building Regulations, 1997

Technical Guidance Document B (Fire Safety) to the Building Regulations, 1997 has been published under Article 7 of the Building Regulations, 1997, for the purpose of providing guidance on how to comply with Part B of the Second Schedule to the Regulations.

Section B1 - Means of Escape in case of Fire

1.0.11.4 Material alterations - Where works constitute a material alteration, and where a material change of use of the building is not also involved, the means of escape requirements of the building regulations for the material alteration may be met by the application of means of escape provisions, together with any other provisions in relation to the protection of escape routes, emergency lighting, fire detection and alarms, fire suppression and building services contained in :

- any relevant Guide or Code of Practice, published by the Department of the Environment for the purpose of providing guidance in relation to satisfying obligations under section 18(2) of the Fire Services Act, 1981.

Section B3 - Internal Fire Spread (Structure)

Material Alteration

3.0.4 In the case of a material alteration of a building and where a material change of use of the building is not also involved, the provisions in relation to the fire resistance for loadbearing elements of Structure (see 3.1) contained in any Guide or Code of Practice, published by the Department of the Environment for the purpose of section 18(2) of the Fire Services Act, 1981, for the type of premises to which the material alteration is carried out, may be used as an alternative to the relevant provisions of this Technical Guidance Document.

Building Control Regulations, 1997

Fire Safety Certificates

Part III (Articles 11 to 20 inclusive) deals with fire safety certification. A fire safety certificate is required for a material alteration of a hostel, to which the requirements of Part B of the Second Schedule to the Building Regulations apply.

A fire safety certificate granted under the Building Control Regulations may be construed as certifying that the building, if constructed in accordance with the plans, documents and information submitted, would comply with the requirements of Part B of the Second Schedule to the Building Regulations.

A fire safety certificate refers only to the design of a building or works. It does not apply to the building or works as constructed.

Commencement Notices

Part II (Articles 7 to 10 inclusive) deals with commencement notices. Commencement notices allow a building control authority to monitor construction for compliance with the Building Regulations. Where a fire safety certificate is required, a commencement notice is also required. They do not relieve the person who carries out the work of responsibility to comply with the requirements of the Building Regulations. A commencement notice is served on the building control authority not less than 14 days and not more than 28 days before the commencement of the works.

Appendix C

Registration and Renewal of Registration Regulations, 1996 for (I) Holiday Hostels and (II) Youth Hostels made under the Tourist Traffic Acts, 1939 - 1995

These Regulations were made by Bord Fáilte under the Tourist Traffic Acts, 1939 - 1995. The following is a brief outline of the main provisions of the above Regulations. It is not intended to be a legal interpretation of the Regulations.

Every application made under section 26 of the Tourist Traffic Act, 1939 for registration of any premises in the Register of Holiday Hostels and Youth Hostels shall be accompanied by, amongst other items, written evidence from a suitably qualified engineer or architect that the fire precautions in the premises are adequate.

The Regulations also set standards for certain facilities in hostels, entrances and exits, dining areas, kitchen and service areas, common rooms, bathrooms and toilets, bedrooms, staff accommodation, storage areas, together with sufficient corridors and stairways to ensure proper circulation and access.

Every application made under section 29 of the Tourist Traffic Act, 1939 for the renewal of registration of any premises in the Register of Holiday Hostels and Youth Hostels shall be accompanied by, amongst other items, particulars of any requirements of the local fire authority, made under the Fire Services Act, 1981, and written evidence that these requirements had been and are being complied with.

Appendix D

In Case Of Fire

Floor Plan

To include ground level plan of area surrounding the premises indicating the assembly points, Indicating : You are Here, Escape Routes, Alarm Points, Extinguishers

Instructions To Guests

If you discover a fire :

Raise the alarm by breaking the glass in the nearest fire alarm call point.

Ring the Fire Brigade from the nearest phone.

On hearing the alarm :

Leave the room closing all doors

Leave the building at once using the nearest escape route

Proceed to the Assembly Point at :

Important points to remember

Do not stop to collect personal belongings

Do not use the lifts

Do not open a door if you suspect a fire on the other side

Do not re-enter the building until advised to do so by the Management

Location of nearest phone

Address of premises

If you are unable to leave the room, place damp towels around the bottom of your room door and seek assistance at a window.

Appendix E

Procedure for Calling the Fire Brigade

Phone the Fire Brigade at 999 or 112 giving the name of the premises, the address, the location and nature of the fire if possible.

Inform the Owner/Warden at

Name of Premises

Address

Appendix F

Fire Safety Register

The Fire Safety Register should contain the following fire safety information :

1. Premises Details
 - Owner
 - Warden/Manager
 - Number of guest bed spaces
 - Person responsible for fire safety
2. Details of Fire Safety Training for Staff
3. Fire and Evacuation Procedures
4. Details of Fire and Evacuation Drills
 - Dates
 - Times
 - Description
 - Follow-up
5. Fire-Fighting Equipment
 - Inventory of equipment
 - Inspection and maintenance details
6. Fire Detection and Alarm System
 - System description
 - Zone details
 - Location of detectors and manual call-points
 - Inspection testing details
 - Maintenance and details of works carried out on the system
7. Emergency Lighting
 - System description and inventory of luminaires
 - Inspection and testing details
 - Maintenance details
 - Details of alterations/works carried out
8. Fire Doors
 - Inventory of fire doors in building
 - Inspection and maintenance details
9. Bedding and Furniture
 - Inventory, suppliers, specifications and test certification for bedding, upholstered furniture, curtains, drapes and floor coverings.

Appendix G

Sample Fire Safety Instructions to Guests

1. Be familiar with the escape routes from your bedroom or dormitory and the procedure for calling the fire brigade.
2. Please obey the "no smoking" signs. Smoking is not allowed in bedrooms or dormitories.
3. Observe all instructions in the use of the kitchen and cooking equipment. Cooking of meals in the kitchen is not permitted after 11 p.m.
4. All gas cartridges/cylinders must be stored outside in the designated store.
5. Keep all gangways and exit routes free of baggage.
6. In the event of an emergency, please follow the instructions of the Warden and his/her assistants.

Appendix H

Materials of Construction

Non-Combustible Materials

- (a) Any material which when tested to BS 476 : Part 11 : 1982 : Method for assessing the heat emission from building materials does not flame and there is no rise in temperature on either the centre (specimen) or furnace thermocouple.
- (b) Totally inorganic materials such as concrete, fired clay, ceramics, metals, plaster and masonry containing not more than 1 per cent by weight or volume of organic material. (Use in buildings of combustible metals such as magnesium/aluminium alloys should be assessed in each individual case).
- (c) Concrete bricks or blocks meeting I.S. 20 : Concrete Building Blocks, Part 1 Normal Density Blocks, I.S. 20 : 1974 : Concrete Building Blocks or I.S. 189 : 1974 : Concrete Building Bricks.
- (d) Products classified as non-combustible under BS 476 : Part 4 : 1970 : Non-combustibility test for materials.

Non-combustible materials may be used whenever there is a requirement for materials of limited combustibility.

Materials of Limited Combustibility

- (a) Any non-combustible material listed above.
- (b) Any material of density 300 kg/m^3 or more which when tested to BS 476 : Part 11, does not flame, and the rise in temperature on the furnace thermocouple is not more than 20°C .
- (c) Any material with a non-combustible core at least 8 mm thick having combustible facings (on one or both sides) not more than 0.5 mm thick. (When a flame spread rating is specified, these materials must also meet the appropriate test requirements).
- (d) Any material of density less than 300 kg/m^3 , which when tested to BS 476 : Part 11 does not flame for more than 10 seconds and the rise in temperature on the centre (specimen) thermocouple is not more than 35°C and on the furnace thermocouple is not more than 25°C .

Typical performance ratings of some generic materials and products

Rating	Material or Product
Class 0	1. Any non-combustible material or material of limited combustibility.
	2. Brickwork, block-work, concrete and ceramic tiles.
	3. Plasterboard (painted or not, with or without an air gap or fibrous or cellular insulating material behind).
	4. Woodwool cement slabs.
	5. Mineral fibre tiles or sheets with cement or resin binding
Class 3	6. Timber or plywood with a density more than 400 kg/m ³ , painted or unpainted.
	7. Wood particle board or hardboard, either treated or painted.
	8. Standard glass reinforced polyesters.
Notes	(1) Materials and products listed under Class 0 also meet Class 1.
	(2) Products listed above under Class 3 may be brought up to Class 1 with appropriate proprietary treatments.

Appendix I

Reference Standards

National Standards Authority of Ireland

I.S. 20	Concrete Building Blocks, Part 1 Normal Density Blocks
I.S. 20 : 1974	Concrete Building Blocks
I.S. 189 : 1974	Concrete Building BRICKS
I.S. 205	Safety of Household and Similar Electrical Appliances Part 1 :1980 : General Requirements
I.S. 254 :1983	Flame Resistance Requirements for Upholstery
I.S. 265 : 1994	Installation of Gas Service Pipes Part 1 : Construction Part 2 : Operation
I.S. 290 : 1986	Portable Fire Extinguishers
I.S. 291 : 1986	The Use, Siting, Inspection and Maintenance of Portable Fire Extinguishers
I.S. 409 : 1988	Self-Contained Smoke Detectors for Private Dwellings
I.S. 415 : 1988	Fire Blankets
I.S. 419 :1988	Fire Safety Requirements for Components of Furniture
I.S. 813 : 1996	Domestic Gas Installations
I.S. 3212 : 1987	Code of Practice for Piped Installation of Fixed Gas Fired Space Heaters in Non Domestic Premises including Places of Assembly
I.S. 3213 : 1987	Code of Practice for the Storage of LPG Cylinders and Cartridges
I.S. 3216 : 1988	Code of Practice for the Storage of LPG at Fixed Installations
I.S. 3217 : 1989	Code of Practice for Emergency Lighting
I.S. 3218 : 1989	Code of Practice for Fire Detection and Alarm Systems for Buildings - System Design, Installation and Servicing

I.C.P.4 :1989	Non-Domestic Installations for Manufactured and Natural Gas (Edition 2)
I.S./EN 3 : 1996	Portable Fire Extinguishers
I.S./EN 671-1 : 1995	Fixed Fire-Fighting Systems Hose Reels with Semi-Rigid Hose
I.S./EN 1021-1 : 1994	Furniture - Assessment of the Ignitability of Upholstered Furniture Part 1 : Smouldering Cigarette

British Standards Institution

BS 476 :	Fire tests on building materials and structures
	Part 4 : 1970 Non-combustibility test for materials
	Part 6 : 1989 Method of test for fire propagation for products
	Part 7 : 1997 Method of test to determine the classification of the surface spread of flame of products
	Part 11 : 1982 Method for assessing the heat emission from building materials
	Part 20 : 1987 Method for determination of the fire resistance of elements of construction (general principles)
	Part 21 : 1987 Methods for determination of the fire resistance of loadbearing elements of construction
	Part 22 : 1987 Methods for determination of the fire resistance of non-loadbearing elements of construction
	Part 23 : 1987 Methods for determination of the contribution of components to the fire resistance of a structure
	Part 24 : 1987 Method for determination of the fire resistance of ventilation ducts
	Part 31 : 1983 Methods of measuring smoke penetration through doorsets and shutter assemblies Section 31.1 : Method of measurement under ambient temperature conditions
BS 3120 : 1959	Specification for performance requirements of flameproof materials for clothing and other purposes
BS 4790 : 1987	Method for determination of the effects of a small source of ignition on textile floor coverings (hot metal nut method)
BS 5287 : 1988	Specification for assessment and labelling of textile floor coverings to BS 4790
BS 5306 :	Fire extinguishing installations and equipment on premises
	Part 1 : 1976 Hydrant systems, hose reels and foam inlets
	Part 3 : 1985 Code of practice for selection, installation and maintenance of portable fire extinguishers

BS 5410 :	Code of practice for oil firing Part 1 : 1997 Installations up to 45 kW output capacity for space heating and hot water supply purposes Part 2 : 1978 Installations of 44 kW and above output capacity for space heating, hot water and steam supply purposes
BS 5499 :	Fire safety signs, notices and graphic symbols Part 1 : 1990 Specification for fire safety signs
BS 5588 :	Fire precautions in the design, construction and use of buildings Part 9 : 1989 Code of practice for ventilation and air conditioning ductwork
BS 5651 : 1978	Cleansing and wetting procedures for use in the assessment of the effect of cleansing and wetting on the flammability of textile fabrics and fabric assemblies
BS 5720 : 1979	Code of practice for mechanical ventilation and air conditioning in buildings
BS EN 1125 : 1997	Building hardware. Panic exit devices operated by a horizontal bar. Requirements and test methods
BS 5784 :	Safety of electrical commercial catering equipment
BS 5839 :	Fire detection and alarm systems for buildings Part 3 : 1988 Specification for automatic release mechanisms for certain fire protection equipment
BS 5867 :	Specification for fabrics for curtains and drapes Part 2 : 1980 Flammability requirements
BS 6575 : 1985	Specification for fire blankets
BS 6807 : 1996	Assessment of the ignitability of mattresses, upholstered divans and upholstered bed bases with flaming types of primary and secondary sources of ignition
BS 8214 : 1990	Code of practice for fire door assemblies with non-metallic leaves
PD 6520 : 1988	Guide to fire test methods for building materials and elements of construction
BS PD 6512	Use of elements of structural fire protection with particular reference to the recommendations given in BS 5588 Part 3 : 1987 Guide to the fire performance of glass

Appendix J

Reference Publications

Title	Address
Technical Guidance Document B (Fire Safety) to the Building Regulations, 1997	Government Publications Sale Office, Sun Alliance House, Molesworth Street, Dublin 2.
Technical Guidance Document K (Stairways, Ladders, Ramps and Guards) to the Building Regulations, 1997	Government Publications Sale Office, Sun Alliance House, Molesworth Street, Dublin 2.
Fire test results on building products : fire propagation. FPA, 1980 (updated 1986)	Fire Protection Association, 140 Aldersgate St., London EC 1A 4HX.
Fire test results on building products : fire resistance. FPA, 1983	Fire Protection Association, 140 Aldersgate St., London EC 1A 4HX.
National Rules for Electrical Installations (ET101 2nd Edition, 1991) Electro-Technical Council of Ireland	Electro-Technical Council of Ireland, Parnell Avenue, Harolds Cross, Dublin 12.
Guidelines for the construction of fire resisting structural elements. Building Research Establishment, 1988 (BR128).	Building Research Establishment Bookshop, Bucknalls Lane, Garston, Watford WD2 RJR.
Increasing the Fire Resistance of Existing Timber Floors. Building Research Establishment, 1988 (Digest 208)	Building Research Establishment Bookshop, Bucknalls Lane, Garston, Watford WD2 RJR.
Fire Protection of Timber Floors. The Association of Specialist Fire Protection Contractors and Manufacturers	PO Box 111, Aldershot, Hampshire GOO 11 1YW.
Fire Protection for Structural Steel in Buildings. The Association of Fire Protection Contractors and Manufacturers, Fire Test Study Group and the Steel Construction Institute	Silwood Park, Ascot, Berks SL5 7QN.